

HCI's Environmental Monitoring Services

CD3 Usage Data Science Project / Hennepin County AIS Pass Through Grant



CD3 Usage Data Science Project Menu

**Background
Information**

HCI

HCI - Hughes Company Innovations Proprietary
www.thehcicompany.com

3

**CD3 Research
Reference Library**

HCI

HCI - Hughes Company Innovations Proprietary
www.thehcicompany.com

11

CD3 Usage Metrics

HCI

HCI - Hughes Company Innovations Proprietary
www.thehcicompany.com

13

Key Project Findings

HCI

HCI - Hughes Company Innovations Proprietary
www.thehcicompany.com

16

Click Buttons to Navigate to Project Menu Item

Background Information

CD3 Data Science Project Summary

Project Name: Data science on Hennepin County CD3 stations analyzing past and current data for better operation, information and decision-making

Project Purpose

- Provide enhanced understanding and transparency on the operation of the CD3 stations of Hennepin County
- Provide analytical insights around the usage of stations, their tools, patterns and timings
- Establish a set of CD3 usage metrics beyond what is currently provided
- Provide insights that will help drive better boater behavior

Project Process

- Consult with Hennepin County staff on CD3 operations
- Gather and assemble past and most recent research and data
- Get familiar with operations at the stations, at landings and remotely
- Run analytics on data
- Share and reflect with stakeholders on findings
- Finalize analytics with additional perspectives
- Make project findings available for reference and path forward

Project Products

- Reference Library of CD3 stations research, investment and operations (sources)
- Data set of usage metrics for stations installed in Hennepin
- Presentation of initial findings for stakeholder reflection
- Summary presentation

CD3 Background Information from Tony Brough

Overview:

CD3 Software was designed to provide maintenance alerts on tankage and tool replacement are intended to labor and costs on CD3 operations. Overall the tool use data design was intended to inform customers on the tool usage and to determine when, how, and what is used. The overarching goal of this data is to inform strategy for customers to save on labor in the form of inspectors a boat access and determine the adoption of the equipment usage.

Key data differences on all CD3 Models

1. All pilot units in 2017 have unique hardware and data organization.

Units prior to 2017

- Bryant Wayside
- North Arm
- Spring Park Mtka Station
- Riley Lake

2. All units after 2018 have different hardware & software. Below is the description is the software programming operation for all units after 2017 pilot units. All other units will have this as a baseline operation of the counts of the units.

Vacuum - Vacuum output will be off until a momentary press of the Vacuum button. After the button press the output will be on for 2 minutes then turn the output off. Pressing the button while the function is on and 30 seconds remaining will reset timer. Pressing the button under 1.5 minutes of the function being on turns the function off. If the vacuum float switch is active the vacuum will turn off and not restart. If the float switch is active the Vac light will flash at a 2 HZ rate.

Blower - Blower output will be off until a momentary press of the Blower button. After the button press the output will be on for 2 minutes then turn the output off. Pressing the button while the function is on and 30 seconds remaining will reset timer. Pressing the button under 1.5 minutes of the function being on turns the function off.

Lights - Lights output will be off until a momentary press of the Lights button. After the button press the output will be on for 10 minutes then turn the output off. Pressing the button while the function is on under 9.5 minutes will turn the lights off.

Stop button - On momentary press of the stop button, the VAC, Blower, and lights will be reset to the off position. If the stop button is held the functions will be off.

Usage Counters

The module will have usage counters for each of the below functions. The counters will be retained in memory. The max values of the counters will be 65535.

- Vacuum
- Blower
- Lights
- Compressor running
- Tool 1
- Tool 2
- Tool 3

The count will increase every time the function starts, if the function button is pressed extending run time, the count will only increment once. If the function is running and the stop button is pressed, the counter will increment once. On the Tool sensors, when the sensor indicates usage there will be a 5 second debounce before counting another use.

Sessions Data

Please ignore all sessions data from 2021. This data was a very conservative count since our algorithm was incorrect due to a timestamp procedure.

CD3 Usage Metrics: Hennepin County Lifetime Totals (09.09.22)

Rank #	Name	Year Installed	Type	Unit Cost	Location	Grabber Count	Brush/Weed Hook Count	Air Uses	Plug Wrench Count	Vacuum Uses	Light Uses	TOTALS	TOTAL %	AVE PER YEAR
1	Riley Wayside	2017	Station	\$20,000	Riley Lake	6814	5086	4619	3465	2415	980	23379	18%	4676
2	Spring Park Mtka Wayside Solar	2017	Station	\$20,000	Spring Lake - Lake Mntka	9605	8152	1813	1393	849	583	22395	18%	4479
3	Bryant Wayside	2017	Station	\$20,000	Bryant Wayside	3470	2448	2583	1698	1580	587	12366	10%	2473
4	North Arm Mtka Wayside	2018	Station	\$20,000	North Arm	3852	2634	2466	1150	1349	897	12348	10%	3087
5	Long Wayside	2018	Station	\$30,671	Long Lake	771	504	3313	962	1913	731	8194	6%	2049
6	Bush Wayside	2018	Station	\$25,300	Bush Lake	1165	240	2548	638	1808	411	6810	5%	1703
7	Spring Park Outpost 2	2018	Outpost	\$12,025	Spring Park Bay	1058	4879	0	655	0	87	6679	5%	1670
8	Medicine Wayside Trailer	2020	Trailer	\$32,975	Medicine Wayside Trailer	919	366	2787	763	862	561	6258	5%	3129
9	Fish Outpost	2020	Outpost	\$12,630	Fish Lake	1479	1660	0	1426	0	372	4937	4%	2469
10	Sarah Outpost	2018	Outpost	\$12,025	Lake Sarah Public Access	1366	1159	0	1256	0	280	4061	3%	1015
11	Weaver Outpost	2019	Outpost	\$12,725	Weaver Lake	1044	1004	0	1383	0	396	3827	3%	1276
12	Parkers Outpost	2018	Outpost	\$12,025	Parkers Lake	1655	648	0	949	0	252	3504	3%	876
13	Spring Park MTLA Outpost 1	2018	Outpost	\$12,025	Spring Park Bay	857	1065	0	806	0	139	2867	2%	717
14	Grays Bay Mtka	2022	Trailer	\$32,975	Grays Bay Mtka	357	327	905	298	357	213	2457	2%	2457
15	Twin Lake	2021	Outpost	\$12,999	Twin Lake	108	430	0	649	3	201	1391	1%	1391
16	Riverside Mississippi Wayside	2021	Wayside	\$30,671	City of Brooklyn Park	217	202	327	113	362	80	1301	1%	1301
17	Carsons Bay Mtka Outpost	2022	Outpost	\$12,999	Grays Bay Mtka	331	140	224	265	113	122	1195	1%	1195
18	Eagle Outpost	2021	Outpost	\$12,725	Eagle Lake	314	139	0	421	0	141	1015	1%	1015
19	Lake Mitchell	2021	Outpost	\$12,999	Twin Lake	310	45	0	388	3	90	836	1%	836
20	Champlin Park	2021	Station	\$34,355	Champlin Park Lower Pt	109	72	280	161	132	53	807	.5%	807
21	Little Long Outpost	2019	Outpost	\$12,725	Little Long Lake	230	186	0	290	0	70	776	.5%	259
22	LMCD Outpost	2022	Outpost	\$12,999	LMCD	254	3	0	35	0	4	296	0%	296
23	Weaver 120v Wayside	2019	Wayside	\$12,725	Weaver 120v Wayside	6	8	20	8	13	22	77	0%	26
					TOTALS	36291	31397	21885	19172	11759	7272	127776		
					TOTAL %	28%	25%	17%	15%	9%	6%			

CD3 Hennepin County Lifetime Financial Costs (09.09.22)

Installment Cost per Year with Type

Year Installed	Year Installment Costs	Total # of Units	Outpost	Station	Trailer	Wayside
2017	\$60,000	3		3		
2018	\$124,071	7	4	3		
2019	\$ 25,450	2	2			
2020	\$45,605	2	1		1	
2021	\$103,749	5	3	1		1
2022	\$58,973	3	2		1	
Total	\$417,848	22	12	7	2	1

Installment Costs per Station Type

Station Type	# of Units	Installment Costs	Total "Uses"
Outpost	12	\$150,901	31384
Station	7	\$170,326	86299
Trailer	2	\$65,950	8715
Wayside	1	\$30,671	1301
Total	22	\$417,848	127699

Hennepin County Yearly Service Costs

Connection and data from the CD3 Portal

- 2017-2018 covered by a state grant awarded to the CD3 company.
- 2019 = \$5,057
- 2020 = \$8,122
- 2021 = \$10,250
- 2022 = \$10,250

Cost per Use by Location

Location	Total Costs	Total "Uses"
Bryant Wayside	\$20,000	12366
Bush Lake	\$25,300	6810
Champlin Park Lower Pt	\$ 34,355	807
City of Brooklyn Park	\$ 30,671	1301
Eagle Lake	\$12,725	1015
Fish Lake	\$12,630	4937
Grays Bay Mtka	\$45,974	3652
Lake Sarah Public Access	\$12,025	4061
Little Long Lake	\$12,725	776
LMCD	\$12,999	296
Long Lake	\$30,671	8194
Medicine Wayside Trailer	\$32,975	6258
North Arm	\$20,000	12348
Parkers Lake	\$12,025	3504
Riley Lake	\$20,000	23379
Spring Lake - Lake Mntka	\$20,000	22395
Spring Park Bay	\$24,050	9546
Twin Lake	\$25,998	2227
Weaver Lake	\$12,725	3827
Total	\$417,848	127699

CD3 Information Story Shared by Tony Brough

So here is an example of fun information I like to share. Looks like Riley Lake CD3 station just surpassed 20,000 total tool uses.

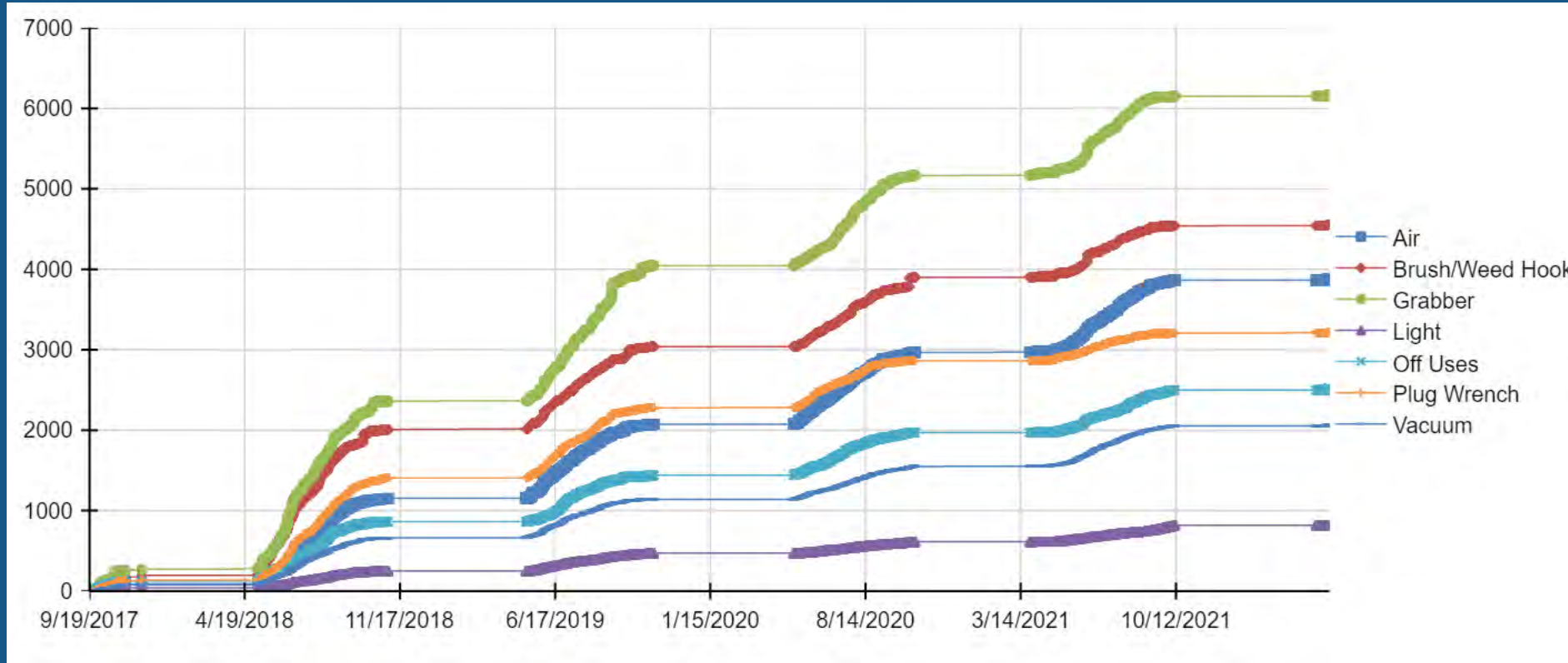

CD3 System Specifications from Owners Manual

1.2.1 Overview Station/Wayside - Front

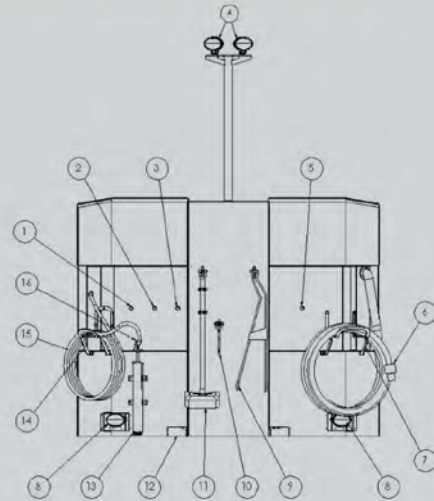

- 1. Blower Function Button (sec. 3.4.3)
- 2. Light Function Button (sec. 3.6)
- 3. "All Off" Function Button (sec. 3.2)
- 4. Upper Lights (sec. 3.2)
- 5. Vacuum Function Button (sec. 3.3.3)
- 6. Vacuum Hose (sec. 3.3.4)
- 7. Vacuum Hose Rack
- 8. Body Light (sec. 3.2)
- 9. Reach Grabber (Tool 3) (sec. 3.5.3)
- 10. Plug Wrench (Tool 2) (sec. 3.5.4)
- 11. Brush (Tool 1) (sec. 3.5.2)
- 12. Fork Tunnel
- 13. Air Blow Gun Holster
- 14. Air Blow Gun Hose Rack
- 15. Air Blow Gun Hose (sec. 3.4.4)
- 16. Air Blow Gun (sec. 3.4.5)

CD³, General Benefit Corporation © 2021

5

1.2.3 Overview - Outpost

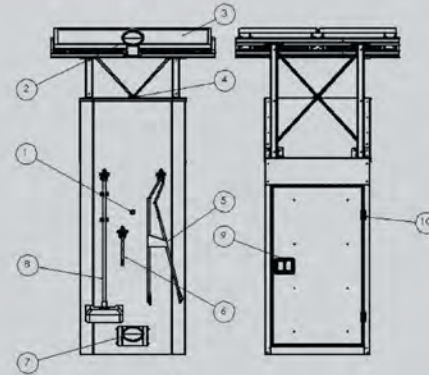

- 1. Light Button Function (sec. 3.6)
- 2. Upper Light (sec. 3.6)
- 3. Solar Panels
- 4. Data Logger Antenna
- 5. Reach Grabber (Tool 3)(sec. 3.5.3)
- 6. Plug Wrench (Tool 2) (sec. 3.5.4)
- 7. Lower Light (sec. 3.6)
- 8. Brush (Tools) (sec. 3.5.2)
- 9. Service Door
- 10. Service Door Lift-Off Hinges

CD³, General Benefit Corporation © 2021

11

Specification Table



General	Station	Wayside 120V	Wayside Solar	Outpost
Overall Height (in)	71.25	71.25	93.5	89.25
Overall Width (in)	92.75	92.75	131.8	44.85
Overall Depth (in)	45.5	45.5	45.25	27.5
Light Pole Height (in)	119.5	119.5	119.5	-
Vacuum Tank Capacity (gal)	108	108	108	-

Tools

Grabber Reach (in)	28	28	28	28
Brush Reach (in)	35	35	35	35
Tool Reel Cable Length (ft)	50	50	50	50
Blow Gun Reach (in)	24	24	24	24
Blow Pressure (psi)	90	90	90	-
Air Hose Diameter (in)	0.375	0.375	0.375	-
Air Hose Length (ft)	35	35	35	-
Vacuum Hose Diameter (in)	2	1.5	1.5	-
Vacuum Hose Length (ft)	25	25	25	-

Electrical

Supply Voltage (VAC)	240	120	-	-
Supply Current (A)	30	15	-	-
Supply Frequency (Hz)	60	60	-	-
Solar Panel Output (W)	-	-	540	100

CD³, General Benefit Corporation © 2021

12

CD3 System Overviews

USER OPERATED EQUIPMENT

- High public approval
- Free public use
- Low maintenance costs

PUBLIC EDUCATION AND INSTRUCTIONS

- Easy to follow prevention steps
- Wifi Hub for public resources, maps and videos
- Graphics and kiosk are customizable

SITE SOFTWARE ANALYTICS

- Internet connected for real-time data
- Software monitors functionality
- Automatic tool tamper alert

CD³ Station

- Waterless, free, user-operated cleaning equipment that includes wet/dry vacuum, blower system, tethered hand tools & lights.
- Designed for continuous use at high traffic boat launches.
- Requires grid connected 240v power with 30 amp service.



USER OPERATED EQUIPMENT

- High public approval
- Free public use
- Low maintenance costs

PUBLIC EDUCATION AND INSTRUCTIONS

- Easy to follow prevention steps
- Wifi Hub for public resources, maps and videos
- Graphics and kiosk are customizable

SITE SOFTWARE ANALYTICS

- Internet connected for real-time data
- Software monitors functionality
- Automatic tool tamper alert

CD³ Wayside Solar

- Waterless, free, user-operated cleaning equipment that includes wet/dry vacuum, blower system, tethered hand tools & lights.
- Off-grid, 620 watt solar array with battery storage provides use for ~10 hours (~85 boats/day).
- Precast base option for easy installation reducing permitting & contracting issues.
- Unit and base bolt together and weighs ~1,900 lbs.
- Vacuum tank emptied by satellite toilet vendor after ~400+ uses.



USER OPERATED EQUIPMENT

- Waterless cleaning systems
- Free public use
- Low maintenance costs

PUBLIC EDUCATION AND INSTRUCTIONS

- Easy to follow prevention steps
- Graphics and kiosk are customizable
- Wifi Hub for public resources, maps and videos

SITE SOFTWARE ANALYTICS

- Software monitors unit functions
- Operational alerts and tool analytics
- Real time data and internet connected

CD³ Outpost

- Solar, waterless, cleaning system with tethered hand tools & lights.
- Targets removal of invasive species at sites with spatial constraints or walk-in users.
- Precast base option for easy installation reducing permitting & contracting issues.
- Unit and base bolt together and weighs ~550 lbs.



CD3 Research Reference Library

CD3 Research Reference Library

#	Name	Summary	Click Link to Access
1	Effectiveness of a CD3 System at Removing Macrophytes and Small-Bodied Invertebrates from Watercraft T. Campbell, M Bodde, Dr T Seilheimer U of Wisconsin Sea Grant Institute 2020	Study finds <u>hand removal</u> as effective as CD3 removal of macrophytes	link
2	In 2021, the Minnesota Legislature approved \$1 million from the state's Environment and Natural Resources Trust Fund for the CD3 stations to combat Starry stonewort.	Millions of public dollars are being spent on CD3 stations in Minnesota	link
3	Lake public access observations for Aquatic Invasive Species prevention behaviors April	Visual observation-based study for 4 Hennepin County locations	link
4	Public access re-design observation summary (2017-2018) by Tony Brough	Summary of vsual observation-based study for 4 Hennepin locations	link
5	Hennepin County Aquatic invasive species prevention website	Home of Hennepin County AIS program information	link
6	Preventing the spread of aquatic invasive species: 2019-2020 accomplishments by Tony Brough Accessed Dec 9th 2021	Summary of Hennepin County AIS accomplishments	Link
7	Hennepin County Green Notes 4/29/2022 featuring Aquatic invasive species prevention successes touting 100,000+ CD3 uses in Hennepin County since 2017 start	Multi-stakeholder Hennepin County celebration of 100,000+ CD3 uses	link
8	M.L. 2021 Approved Work Plan Stop Starry Invasion. Budget: \$1,000,000	Environment and Natural Resources Trust Fund \$1,000,000 CD3 grant	Link
9	CD3 stations website CD3 software orientation	CD3 video training materials	Link
10	CD3 stations installed and proposed to date	Google map of all CD3 locations in Hennepin County and broader US	link
11	MN DNR boating 'Clean In Clean Out' reference website	MN DNR recommends cleaning boats with high-pressure very hot water 120-140 F	link
12	Minnesota State Statute 84D.10 Watercraft And Water-related Equipment Requirements And Prohibitions	Illegal in MN to transport AIS on any roadway, launch a watercraft with AIS, or transport water from MN waterways	link

CD3 Usage Metrics

CD3 Usage Metrics Main Menu

**Hennepin Station Specific
CD3 Usage Metrics**

Metric Definitions

HCI - Hughes Company Innovations Proprietary
www.thehcicompany.com

HCI

19

**Hennepin Station Specific
CD3 Usage Metrics**

Trailer Stations

HCI - Hughes Company Innovations Proprietary
www.thehcicompany.com

HCI

20

**Hennepin Station Specific
CD3 Usage Metrics**

Wayside Stations

HCI - Hughes Company Innovations Proprietary
www.thehcicompany.com

HCI

18

**Hennepin Station Specific
CD3 Usage Metrics**

Outpost Stations

HCI - Hughes Company Innovations Proprietary
www.thehcicompany.com

HCI

42

Click Buttons to Navigate to Project Menu Item

Hennepin Station Specific CD3 Usage Metrics

Metric Definitions

Spring Park Mtka Wayside Solar (a)



Metrics Menu

1 - Tool use by hour for station lifetime (green = high / red = low)

- Hourly use by tool for lifetime of station
- Green = high # of tool uses per tool for 24 periods
- Red = low # of tool uses per tool for 24 periods
- Key Insights: time of day use intensity, cross tool use patterns
- Data Anomaly Detection: night and excessive period use

	12 AM	1 AM	2 AM	3 AM	4 AM	5 AM	6 AM	7 AM	8 AM	9 AM	10 AM	11 AM	12 PM	1 PM	2 PM	3 PM	4 PM	5 PM	6 PM	7 PM	8 PM	9 PM	10 PM	11 PM	Total
Air	4	1	4	2	0	3	19	38	39	61	99	101	87	103	106	151	228	177	161	178	152	67	56	14	1851
Brush/Weed Hook	97	110	77	89	80	56	133	144	210	312	443	437	504	487	575	665	781	811	531	552	436	399	312	221	8242
Grabber	104	367	346	309	100	116	123	192	401	395	694	803	690	540	690	465	848	547	442	413	348	260	213	342	9748
Light	5	3	1	2	1	4	1	5	12	11	15	8	7	11	11	15	16	17	36	73	118	115	75	35	597
Plug Wrench	2	2	1	1	4	1	12	18	33	51	93	91	58	84	138	92	131	119	125	130	133	52	35	14	1429
Vacuum	0	1	0	0	0	4	14	7	45	38	52	72	56	60	56	68	101	80	57	67	66	30	13	8	875
Total	212	484	429	403	165	184	302	404	740	868	1396	1512	1402	1285	1576	1456	2105	1531	1352	1422	1253	923	704	634	22742

2- Yearly tool use for night time periods (green = low / red = high)

	12 AM	1 AM	2 AM	3 AM	4 AM	5 AM	6 AM	11 PM	Total
2017	28	2	14	11	2	2	2	55	116
2018	234	110	112	55	65	66	87	211	940
2019	56	29	84	68	51	55	61	75	479
2020	61	29	9	8	6	15	7	139	273
2021	42	3	13	31	15	13	6	124	247
2022	193	65	250	256	264	12	20	135	1185
Total	614	237	482	429	403	163	183	739	3250

- Hourly station use by year
- Green = high # of tool uses per tool for time periods (yr/hr)
- Red = low # of tool uses per tool for time periods (yr/hr)
- Key Insights: time of day, yearly use intensity, trends
- Data Anomaly Detection: night, excessive period use, yearly uses

4 - Tool use by day for station lifetime (green = high / red = low)

	Sun	Mon	Tue	Wed	Thu	Fri	Sat	Total
Air	315	207	184	181	197	247	317	1851
Brush/Weed Hook	1217	1062	899	895	798	1349	1792	8242
Grabber	1848	367	1023	990	1802	970	3236	9748
Light	107	77	75	71	75	84	106	597
Plug Wrench	272	176	127	148	163	197	348	1429
Vacuum	158	100	106	105	149	88	169	875
Total	4538	3389	2174	2394	3144	2944	5159	22742

- Daily tool use for lifetime of station
- Green = high # of tool uses per tool and overall for week
- Red = low # of tool uses per tool and overall for week
- Key Insights: day of the week tool use intensity
- Data Anomaly Detection: high mid-week use

3 - Tool use by year (green = high / red = low / *2017 not included)

	2017	2018	2019	2020	2021	2022	Total
Air	196	568	327	233	264	265	1851
Brush/Weed Hook	555	2509	1433	1563	1311	871	8242
Grabber	365	1437	2352	1022	2073	2406	9748
Light	81	141	102	107	93	72	597
Plug Wrench	149	404	311	224	174	167	1429
Vacuum	71	312	151	85	114	142	875
Total	1417	5369	4676	3234	4029	4017	22742
Minus Nighttime	1301	4429	4107	3782	3782	2922	19492

- Tool use by year
- Green = high # of tool uses per tool and total by year
- Red = low # of tool uses per tool and total by year
- Key Insights: time of day, yearly use intensity, trends
- Data Anomaly Detection: yearly use levels

5 - Key Insights

#	Metric	Value	#	Metric	Value
1	Hour with Most Uses	4:00 PM	6	Yearly Use Trend 21 to 22	Down
2	Day with Most Uses	Saturday	7	Tool with Most Uses	Grabber
3	Day with 2nd Most Uses	Sunday	8	Tool with Least Uses	Light
4	Year with Most Uses	2018	9	Significant Outliers Detected	YES
5	Year with Least Uses *	2022			

- Important usage data points
- Key Insights: per station and meta-analysis, trends
- Data Anomaly Detection: **Significant Outliers Detected**

Spring Park Mtka Wayside Solar (b)



Metrics Menu

6 - Average daily tool use per month

	2017				2018				2019				2020				2021				2022																
	Aug	Sep	Oct	Nov	May	Jun	Jul	Aug	Sep	Oct	Apr	May	Jun	Jul	Aug	Sep	Oct	Jan	Jul	Aug	Sep	Oct	Mar	Apr	May	Jun	Jul	Aug	Sep	Oct	Apr	May	Jun	Jul	Aug	Sep	Oct
Air	2	2	2	0	3	4	3	4	3	2	1	1	2	2	1	2	1	2	2	2	1	0	0	1	2	2	1	1	0	1	2	2	2	2	0		
Brush/Weed Hook	1	9	6	0	4	23	12	13	9	21	1	14	8	11	7	1	4	3	25	6	5	12	4	2	5	8	8	9	6	1	0	4	12	5	4	3	1
Grabbie	1	3	7	0	3	5	3	5	3	27	1	5	2	7	4	1	13	2	5	6	11	9	0	1	5	15	12	13	20	3	0	2	5	10	8	12	0
Light	1	1	1	0	1	1	0	1	1	1	0	0	1	1	0	0	0	1	1	1	1	0	0	0	1	1	1	1	0	0	0	1	1	1	1	0	
Flag Wrench	0	3	3	0	2	3	2	2	2	2	0	1	2	2	0	2	1	3	1	0	2	0	1	0	1	1	1	1	1	0	1	1	1	1	1	0	
Vacuum	0	1	1	0	2	2	1	2	2	1	0	1	1	1	0	1	0	1	1	1	0	0	0	0	1	1	1	1	0	0	1	2	1	0	1	0	
Total	5	19	21	1	15	39	21	27	20	54	4	22	16	23	13	22	8	35	17	20	24	5	3	11	28	24	25	29	6	0	9	37	19	15	30	2	
Days in Month	31	30	31	30	31	30	31	31	30	31	30	31	30	31	31	30	31	30	31	31	30	31	31	30	31	30	31	31	30	31	30	31	30	31	31	30	31

- Average daily use per tool per month/year
- Key Insights: tool daily use intensity, trends
- Data Anomaly Detection: outlier monthly use

7 - July 4th tool use per year

	2018	2019	2020	2021	2022	Total
Air	2	7	3	4	4	20
Brush/Weed Hook	4	9	14	8	12	104
Grabbie	0	4	23	55	1	83
Light	0	0	0	1	4	5
Flag Wrench	2	0	16	0	0	18
Vacuum	2	0	1	3	0	5
Total	10	19	57	128	21	235

- July 4th single day tool use per year
- Key Insights: holiday use intensity, yearly trends, comparative analysis
- Data Anomaly Detection: use outliers

8 - Tool use by month per year (green = high / red = low)

	Mar	Apr	May	Jun	Jul	Aug	Sep	Oct	Nov	Total
2017						167	575	852	21	1417
2018			476	1156	847	831	539	1888		5387
2019		113	692	481	722	1920	91	671		4876
2020			228	1649	530	812	759			3978
2021	152	100	350	322	744	791	382	188		4029
2022		1	278	2011	1881	465	852	26		4017
Total	722	214	1790	4302	3795	4695	3360	4011	23	22342

- Yearly station tool use by month all tools
- Green = high # of tool uses per year and total
- Red = low # of tool uses per year and total
- Key Insights: yearly and monthly use intensity, trends
- Data Anomaly excessive or missing period use, yearly uses

9 - Tool use by month per year trends

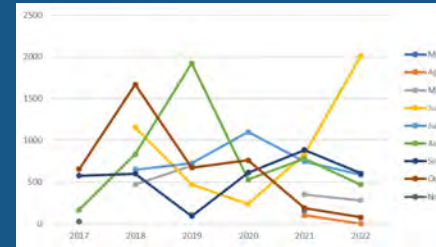

- Month over month tool use all tools per year
- Key Insights: monthly use comparisons, month over month, trends
- Data Anomaly Detection: excessive or missing period use

*** Note: 'Light Off' use information was NOT included in this analysis**

Hennepin Station Specific CD3 Usage Metrics

Wayside Stations

CD3 Usage Metrics Wayside Menu

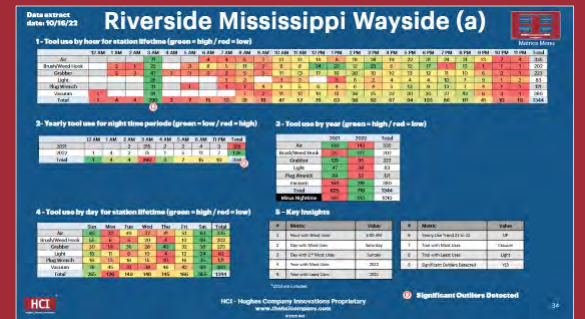
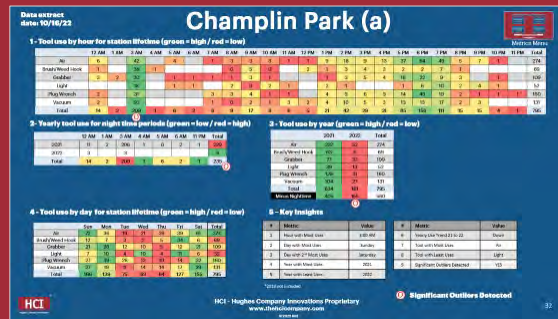
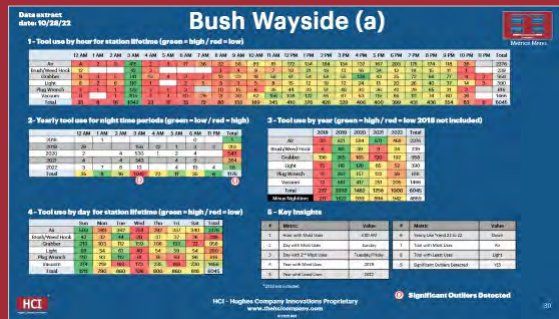
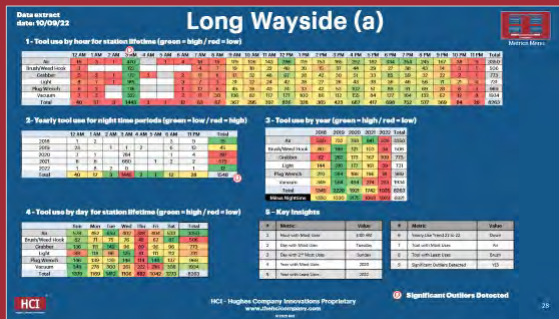
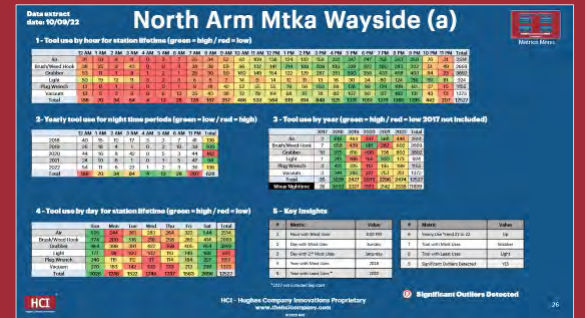
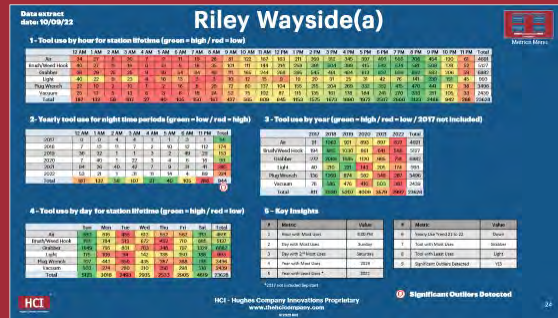
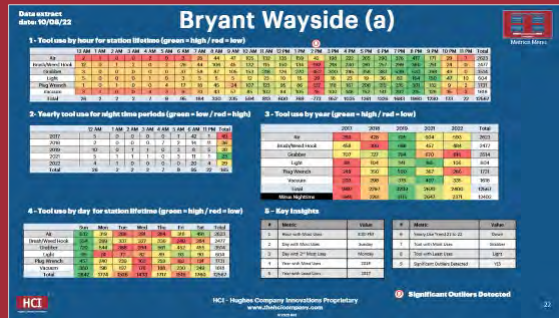
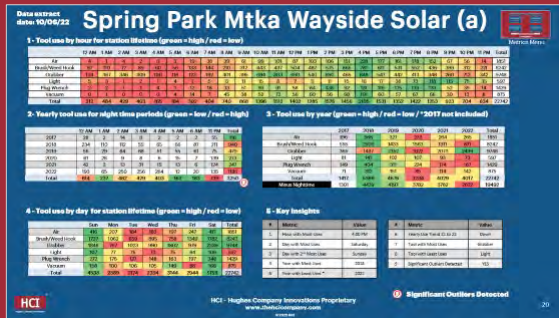

Click Buttons to Navigate to CD3 Location Metrics



Spring Park Mtka Wayside Solar (a)



Metrics Menu

1 - Tool use by hour for station lifetime (green = high / red = low)

	12 AM	1 AM	2 AM	3 AM	4 AM	5 AM	6 AM	7 AM	8 AM	9 AM	10 AM	11 AM	12 PM	1 PM	2 PM	3 PM	4 PM	5 PM	6 PM	7 PM	8 PM	9 PM	10 PM	11 PM	Total
Air	4	1	4	2	0	3	19	38	39	61	99	101	87	103	106	151	228	177	161	178	152	67	56	14	1851
Brush/Weed Hook	97	110	77	89	60	56	133	144	210	312	443	437	504	487	575	665	781	611	531	552	436	399	312	221	8242
Grabber	104	367	346	309	100	116	123	192	401	395	694	803	690	540	690	465	848	547	442	413	348	260	213	342	9748
Light	5	3	1	2	1	4	1	5	12	11	15	8	7	11	15	16	17	36	73	118	115	75	35	35	597
Plug Wrench	2	2	1	1	4	1	12	18	33	51	93	91	58	84	138	92	131	119	125	139	133	52	35	14	1429
Vacuum	0	1	0	0	0	4	14	7	45	38	52	72	56	60	56	68	101	60	57	67	66	30	13	8	875
Total	212	484	429	403	165	184	302	404	740	868	1396	1512	1402	1285	1576	1456	2105	1531	1352	1422	1253	923	704	634	22742

2 - Yearly tool use for night time periods (green = low / red = high)

	12 AM	1 AM	2 AM	3 AM	4 AM	5 AM	6 AM	11 PM	Total
2017	28	2	14	11	2	2	2	55	116
2018	234	110	112	55	65	66	87	211	940
2019	56	29	84	68	51	55	61	75	479
2020	61	28	9	8	6	15	7	139	273
2021	42	3	13	31	15	13	6	124	247
2022	193	65	250	256	264	12	20	135	1195
Total	614	237	482	429	403	163	183	739	3250

3 - Tool use by year (green = high / red = low / *2017 not included)

	2017	2018	2019	2020	2021	2022	Total
Air	196	566	327	233	264	265	1851
Brush/Weed Hook	555	2509	1433	1563	1311	871	8242
Grabber	365	1437	2352	1022	2073	2499	9748
Light	81	141	102	107	93	73	597
Plug Wrench	149	404	311	224	174	167	1429
Vacuum	71	312	151	85	114	142	875
Total	1417	5369	4676	3234	4029	4017	22742
Minus Nighttime	1301	4429	4197	3782	3782	2822	19492

4 - Tool use by day for station lifetime (green = high / red = low)

	Sun	Mon	Tue	Wed	Thu	Fri	Sat	Total
Air	416	207	184	183	197	247	417	1851
Brush/Weed Hook	1737	1062	659	895	758	1349	1782	8242
Grabber	1848	767	1023	990	1802	979	2339	9748
Light	107	77	75	73	75	84	106	597
Plug Wrench	272	176	127	148	163	197	346	1429
Vacuum	158	100	106	105	149	88	169	875
Total	4538	2389	2174	2394	3144	2944	5159	22742

5 - Key Insights

#	Metric	Value
1	Hour with Most Uses	4:00 PM
2	Day with Most Uses	Saturday
3	Day with 2 nd Most Uses	Sunday
4	Year with Most Uses	2018
5	Year with Least Uses *	2022

#	Metric	Value
6	Yearly Use Trend 21 to 22	Down
7	Tool with Most Uses	Grabber
8	Tool with Least Uses	Light
9	Significant Outliers Detected	YES

Significant Outliers Detected

Spring Park Mtka Wayside Solar (b)



Metrics Menu

6 - Average daily tool use per month

	2017				2018					2019				2020					2021					2022														
	Aug	Sep	Oct	Nov	May	Jun	Jul	Aug	Sep	Oct	Apr	May	Jun	Jul	Aug	Sep	Oct	Jun	Jul	Aug	Sep	Oct	Mar	Apr	May	Jun	Jul	Aug	Sep	Oct	Apr	May	Jun	Jul	Aug	Sep	Oct	
Air	2	2	2	0	3	4	3	4	3	2	1	1	2	2	1	2	1	2	2	2	1	1	0	0	1	2	2	2	1	1	0	1	2	2	2	0		
Brush/Weed Hook	1	9	8	0	4	23	12	13	9	21	1	14	8	11	7	1	4	3	25	6	5	12	4	2	5	8	8	9	6	1	0	4	12	5	4	3	1	
Grabber	1	3	7	0	3	5	3	5	3	27	1	5	2	7	48	1	13	2	5	6	11	9	0	1	5	15	12	13	20	3	0	2	50	10	8	12	0	
Light	1	1	1	0	1	1	0	1	1	1	0	0	1	1	1	0	0	0	1	1	1	1	0	0	0	1	1	1	1	0	0	1	1	0	1	0		
Plug Wrench	0	2	2	0	2	3	2	2	2	2	0	1	2	2	2	0	2	1	3	1	0	2	0	1	0	1	1	1	1	1	0	1	1	1	1	0		
Vacuum	0	1	1	0	2	2	1	2	2	1	0	1	1	1	1	0	1	0	1	1	1	0	0	0	0	1	1	1	1	0	0	1	2	1	0	1	0	
Total	5	19	21	1	15	39	21	27	20	54	4	22	16	23	62	3	22	8	35	17	20	24	5	3	11	28	24	25	29	6	0	9	67	19	15	20	2	
Days in Month	31	30	31	30	31	30	31	31	30	31	30	31	30	31	31	30	31	30	31	31	30	31	31	30	31	30	31	31	30	31	30	31	31	30	31	31	30	31

7 - July 4th tool use per year

	2018	2019	2020	2021	2022	Total
Air	2	7	3	4	4	20
Brush/Weed Hook	4	8	14	66	12	104
Grabber	0	4	23	55	1	83
Light	0	0	0	1	4	5
Plug Wrench	2	0	16	0	0	18
Vacuum	2	0	1	2	0	5
Total	10	19	57	128	21	235

8 - Tool use by month per year (green = high / red = low)

	Mar	Apr	May	Jun	Jul	Aug	Sep	Oct	Nov	Total
2017						167	575	652	23	1417
2018			470	1156	647	831	599	1666		5369
2019		113	692	468	722	1920	90	671		4676
2020				235	1098	530	612	759		3234
2021	152	100	350	832	744	781	882	188		4029
2022		1	278	2011	584	466	602	75		4017
Total	152	214	1790	4702	3795	4695	3360	4011	23	22742

9 - Tool use by month per year trends

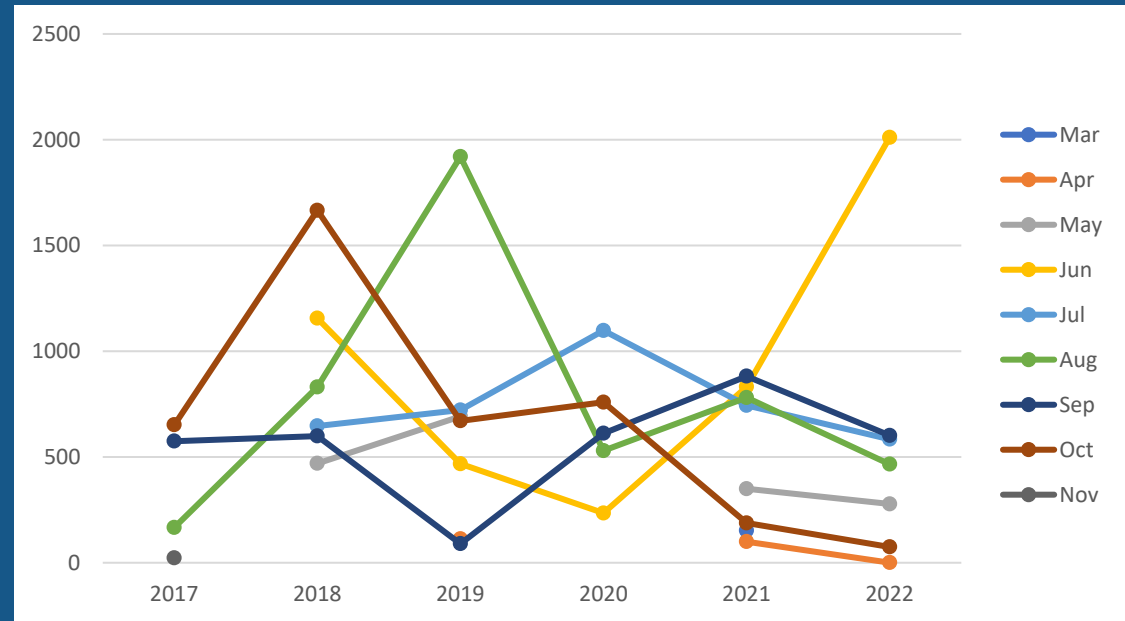

⊙ ⊙ ⊙

Bryant Wayside (a)



Metrics Menu

1 - Tool use by hour for station lifetime (green = high / red = low)



	12 AM	1 AM	2 AM	3 AM	4 AM	5 AM	6 AM	7 AM	8 AM	9 AM	10 AM	11 AM	12 PM	1 PM	2 PM	3 PM	4 PM	5 PM	6 PM	7 PM	8 PM	9 PM	10 PM	11 PM	Total
Air	2	1	0	0	2	0	3	26	44	47	105	132	135	159	42	198	222	265	290	326	417	171	29	7	2623
Brush/Weed Hook	12	0	1	2	0	2	26	44	106	45	132	115	150	134	-192	218	230	261	257	299	360	251	24	0	2477
Grabber	3	0	0	0	0	0	37	58	87	105	153	318	126	270	-452	300	245	358	387	539	533	398	49	0	3514
Light	5	0	0	0	1	0	3	5	5	5	12	23	10	15	-29	18	23	19	36	82	164	150	47	10	604
Plug Wrench	1	0	1	0	0	4	17	18	45	-24	107	123	95	86	-127	118	167	206	215	235	301	132	9	2	1731
Vacuum	3	1	0	0	4	3	9	33	43	57	85	102	84	105	-15	100	148	152	141	202	215	128	15	3	1618
Total	26	2	2	2	7	9	95	184	330	235	594	813	600	769	-773	952	1035	1261	1326	1683	1990	1230	173	22	12567

2- Yearly tool use for night time periods (green = low / red = high)

	12 AM	1 AM	2 AM	3 AM	4 AM	5 AM	6 AM	11 PM	Total
2017	5	0	0	0	0	1	42	1	49
2018	2	0	0	0	7	2	14	11	36
2019	10	0	1	1	0	3	8	5	28
2021	5	1	1	1	0	3	11	1	23
2022	4	1	0	0	0	0	20	4	29
Total	26	2	2	2	7	9	95	22	165

3 - Tool use by year (green = high / red = low)

	2017	2018	2019	2021	2022	Total
Air	293	428	705	604	593	2623
Brush/Weed Hook	458	390	688	457	484	2477
Grabber	707	727	794	670	616	3514
Light	88	104	141	165	106	604
Plug Wrench	248	350	500	367	266	1731
Vacuum	203	298	375	407	335	1618
Total	1997	2297	3203	2670	2400	12567
Minus Nighttime	1948	2261	3175	2647	2371	12402

4 - Tool use by day for station lifetime (green = high / red = low)

	Sun	Mon	Tue	Wed	Thu	Fri	Sat	Total
Air	632	319	288	291	284	318	491	2623
Brush/Weed Hook	554	399	337	327	336	240	284	2477
Grabber	720	544	388	394	561	452	455	3514
Light	99	74	77	82	89	93	90	604
Plug Wrench	457	240	239	163	259	182	191	1731
Vacuum	380	198	197	176	188	230	249	1618
Total	2842	1774	1526	1433	1717	1515	1760	12567

5 - Key Insights

#	Metric	Value
1	Hour with Most Uses	8:00 PM
2	Day with Most Uses	Sunday
3	Day with 2 nd Most Uses	Monday
4	Year with Most Uses	2019
5	Year with Least Uses	2017

#	Metric	Value
6	Yearly Use Trend 21 to 22	Down
7	Tool with Most Uses	Grabber
8	Tool with Least Uses	Light
9	Significant Outliers Detected	YES

Significant Outliers Detected

Bryant Wayside (b)



Metrics Menu

6 - Average daily tool use per month

	2017						2018						2019						2021						2022								
	Jun	Jul	Aug	Sep	Oct	Nov	Jun	Jul	Aug	Sep	Oct	Nov	Apr	May	Jun	Jul	Aug	Sep	Oct	Mar	Apr	May	Jun	Jul	Aug	Sep	Oct	Apr	May	Jun	Jul	Aug	Sep
Air	1	0	3	3	1	0	2	6	3	2	1	0	0	3	6	6	4	3	0	0	0	4	4	5	4	2	0	0	4	5	6	2	2
Brush/Weed Hook	2	-1	6	4	3	0	2	3	3	3	0	0	0	4	6	6	3	3	0	1	1	2	2	3	3	3	1	1	3	5	5	1	1
Grabber	1	2	10	6	4	0	6	9	5	4	0	0	0	3	5	10	4	3	0	1	0	3	3	5	6	4	1	0	3	8	5	2	2
Light	0	0	1	1	0	0	1	1	1	0	0	0	0	1	1	1	1	1	0	0	0	2	1	1	1	1	0	0	1	1	1	0	1
Plug Wrench	1	0	4	3	1	0	2	4	2	3	1	0	0	2	5	5	2	1	0	1	0	3	2	3	2	1	0	0	1	3	2	1	1
Vacuum	1	0	2	2	2	0	1	3	2	2	1	0	0	2	3	3	2	2	1	0	0	3	2	4	2	1	0	0	2	3	3	1	2
Total	6	2	26	20	11	0	15	26	17	14	4	0	0	15	27	32	16	12	2	3	2	16	14	20	18	11	3	1	14	25	22	7	10
Days in Month	30	31	31	30	31	30	30	31	31	30	31	30	30	31	30	31	31	30	31	31	30	31	30	31	31	30	31	30	31	30	31	31	30

7 - July 4th tool use per year

Labels	2017	2018	2019	2021	2022	Total
Air	9	18	4	3	4	38
Brush/Weed Hook	4	14	2	4	13	37
Grabber	84	17	4	12	1	118
Light	1	2	1	2	2	8
Plug Wrench	23	6	8	1	5	43
Vacuum	3	10	0	4	0	17
Total	124	67	19	26	25	261

8 - Tool use by month per year (green = high / red = low)

	Mar	Apr	May	Jun	Jul	Aug	Sep	Oct	Nov	Total
2017				193	52	821	589	336	6	1997
2018				440	797	513	429	118	0	2297
2019		6	463	814	983	502	372	63		3203
2021	91	70	501	412	618	555	341	82		2670
2022		38	429	752	670	226	285			2400
Total	91	114	1393	2611	3120	2617	2016	599	6	12567

9 - Tool use by month per year trends

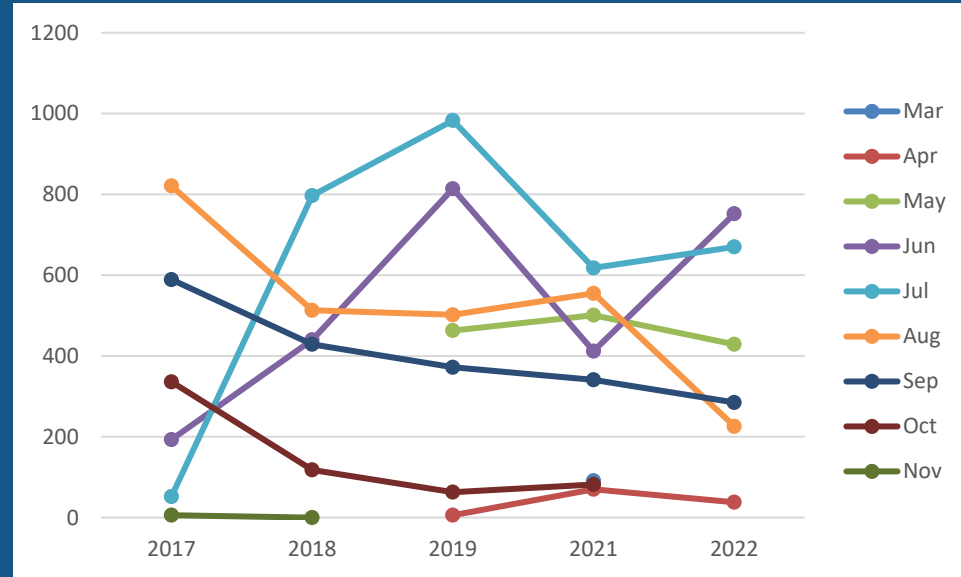

Riley Wayside(a)



Metrics Menu

1 - Tool use by hour for station lifetime (green = high / red = low)

	12 AM	1 AM	2 AM	3 AM	4 AM	5 AM	6 AM	7 AM	8 AM	9 AM	10 AM	11 AM	12 PM	1 PM	2 PM	3 PM	4 PM	5 PM	6 PM	7 PM	8 PM	9 PM	10 PM	11 PM	Total
Air	34	27	6	20	7	2	11	19	28	81	122	167	163	211	269	312	345	397	493	566	706	454	190	61	4691
Brush/Weed Hook	40	27	11	16	0	13	5	18	35	101	111	144	214	258	391	504	389	415	542	574	581	508	178	52	5127
Grabber	26	29	25	25	9	10	54	84	48	111	165	244	268	395	545	461	484	613	837	699	892	593	206	59	6882
Light	40	22	9	23	4	10	13	3	3	10	12	15	9	19	20	31	25	31	42	76	141	239	151	45	993
Plug Wrench	22	10	2	10	1	2	16	8	29	72	80	137	104	155	215	204	269	332	352	415	470	441	112	38	3496
Vacuum	25	17	5	13	6	3	6	18	24	52	75	102	87	115	135	161	178	184	241	270	333	251	105	33	2439
Total	187	132	58	107	27	40	105	150	167	427	565	809	845	1153	1575	1673	1690	1972	2507	2600	3123	2486	942	288	23628

2- Yearly tool use for night time periods (green = low / red = high)

	12 AM	1 AM	2 AM	3 AM	4 AM	5 AM	6 AM	11 PM	Total
2017	0	0	4	4	1	1	3	1	14
2018	7	13	11	7	2	10	12	112	174
2019	36	32	1	1	3	2	49	29	153
2020	7	40	1	22	3	4	6	16	99
2021	84	26	40	42	7	9	31	41	280
2022	53	21	1	31	11	14	4	89	224
Total	187	132	58	107	27	40	105	288	944



3 - Tool use by year (green = high / red = low / 2017 not included)

	2017	2018	2019	2020	2021	2022	Total
Air	91	1062	921	893	897	827	4691
Brush/Weed Hook	194	1815	1030	861	641	586	5127
Grabber	272	2089	1685	1120	985	731	6882
Light	40	210	221	143	205	174	993
Plug Wrench	136	1269	874	582	348	287	3496
Vacuum	78	585	476	410	503	387	2439
Total	811	7030	5207	4009	3579	2992	23628

4 - Tool use by day for station lifetime (green = high / red = low)

	Sun	Mon	Tue	Wed	Thu	Fri	Sat	Total
Air	980	616	455	613	552	562	913	4691
Brush/Weed Hook	1111	784	513	672	452	710	885	5127
Grabber	1649	795	801	763	748	797	1329	6882
Light	175	106	94	142	138	150	188	993
Plug Wrench	707	443	350	435	387	388	786	3496
Vacuum	503	274	280	310	256	298	518	2439
Total	5125	3018	2493	2935	2533	2905	4619	23628

5 - Key Insights

#	Metric	Value
1	Hour with Most Uses	8:00 PM
2	Day with Most Uses	Sunday
3	Day with 2 nd Most Uses	Saturday
4	Year with Most Uses	2019
5	Year with Least Uses *	2022

*2017 not included Sep start

#	Metric	Value
6	Yearly Use Trend 21 to 22	Down
7	Tool with Most Uses	Grabber
8	Tool with Least Uses	Light
9	Significant Outliers Detected	YES

Significant Outliers Detected

Riley Wayside (b)



Metrics Menu

6 - Average daily tool use per month

	2017			2018						2019						2020						2021						2022								
	Sep	Oct	Nov	May	Jun	Jul	Aug	Sep	Oct	Nov	May	Jun	Jul	Aug	Sep	Oct	May	Jun	Jul	Aug	Sep	Oct	Mar	Apr	May	Jun	Jul	Aug	Sep	Oct	Apr	May	Jun	Jul	Aug	Sep
Air	1	2	0	5	7	9	8	4	1	0	5	8	6	6	4	1	5	7	7	6	3	1	0	1	5	7	7	6	3	0	0	3	9	7	4	5
Brush/Weed Hook	2	4	1	12	17	11	10	8	2	0	5	9	7	6	5	1	4	5	8	5	2	4	0	1	3	7	6	3	2	0	0	2	3	4	7	4
Grabber	1	7	0	10	22	13	11	8	4	0	6	13	11	12	10	4	5	6	12	8	5	1	0	1	4	11	8	7	1	0	0	2	3	7	8	4
Light	0	1	0	1	2	1	2	1	0	0	1	2	1	1	1	0	0	1	1	1	1	1	0	0	1	1	1	1	2	1	0	1	2	1	1	1
Plug Wrench	1	3	1	5	12	8	9	6	2	0	4	9	5	7	3	1	4	6	4	4	1	0	0	0	3	3	3	2	1	0	0	2	1	2	2	2
Vacuum	0	2	0	3	4	5	4	3	1	0	3	5	3	3	2	0	3	2	3	3	2	1	0	0	3	5	4	3	2	0	0	3	5	2	1	2
Total	5	19	2	35	63	47	45	29	10	0	24	46	32	36	25	8	20	27	36	26	15	8	1	3	18	34	29	22	10	2	1	12	23	24	23	16
Days in Month	30	31	30	31	30	31	31	30	31	30	31	30	31	31	30	31	31	30	31	30	30	31	31	30	31	30	30	31	30	31	30	31	30	30	31	30

7 - July 4th tool use per year

	2018	2019	2020	2021	2022	Total
Air	10	17	16	9	16	68
Brush/Weed Hook	19	12	6	3	2	42
Grabber	2	59	18	15	12	106
Light	1	3	3	3	3	13
Plug Wrench	6	12	1	2	1	22
Vacuum	12	8	6	9	2	37
Total	50	111	50	41	36	288

8 - Tool use by month per year (green = high / red = low)

	Mar	Apr	May	Jun	Jul	Aug	Sep	Oct	Nov	Total
2017							162	588	61	811
2018			1094	1900	1456	1383	884	306	7	7030
2019			744	1366	997	1120	735	245		5207
2020			623	796	1104	785	440	261		4009
2021	23	87	548	1005	868	686	306	56		3579
2022		18	363	681	713	727	490			2992
Total	23	105	3372	5748	5138	4701	3017	1456	68	23628

9 - Tool use by month per year trends

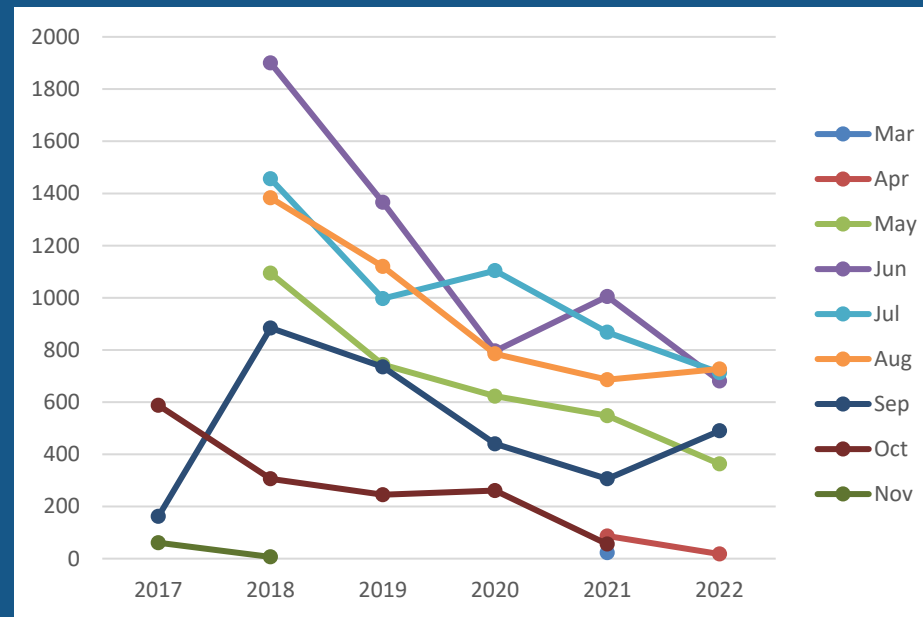

North Arm Mtka Wayside (a)



Metrics Menu

1 - Tool use by hour for station lifetime (green = high / red = low)

	12 AM	1 AM	2 AM	3 AM	4 AM	5 AM	6 AM	7 AM	8 AM	9 AM	10 AM	11 AM	12 PM	1 PM	2 PM	3 PM	4 PM	5 PM	6 PM	7 PM	8 PM	9 PM	10 PM	11 PM	Total
Air	21	10	9	11	0	3	7	25	34	52	92	109	136	124	132	158	222	247	247	255	263	250	76	31	2514
Brush/Weed Hook	38	25	9	43	0	0	3	28	36	59	96	132	141	214	189	209	190	229	223	260	243	202	51	49	2669
Grabber	53	11	1	8	1	2	1	25	30	59	160	149	154	122	129	287	351	590	358	433	458	403	84	23	3892
Light	50	19	12	11	3	2	3	6	6	7	14	9	14	12	11	13	16	30	34	80	124	216	151	81	924
Plug Wrench	13	0	1	5	0	0	1	9	18	42	52	55	55	79	56	103	66	128	99	124	109	93	37	10	1155
Vacuum	13	5	2	6	0	6	13	35	43	38	72	79	64	68	97	78	80	107	90	127	163	131	43	13	1373
Total	188	70	34	84	4	13	28	128	167	257	486	533	564	619	614	848	925	1331	1051	1279	1360	1295	442	207	12527

2- Yearly tool use for night time periods (green = low / red = high)

	12 AM	1 AM	2 AM	3 AM	4 AM	5 AM	6 AM	11 PM	Total
2018	40	15	10	17	3	3	7	41	136
2019	26	18	4	1	0	2	10	39	100
2020	44	16	8	42	0	5	3	44	162
2021	24	10	6	1	0	1	5	47	94
2022	54	11	6	23	1	2	3	36	136
Total	188	70	34	84	4	13	28	207	628

3 - Tool use by year (green = high / red = low 2017 not included)

	2017	2018	2019	2020	2021	2022	Total
Air	2	618	483	397	568	446	2514
Brush/Weed Hook	7	658	439	681	282	602	2669
Grabber	10	975	816	490	798	803	3892
Light	1	213	169	168	200	173	924
Plug Wrench	3	421	225	112	195	199	1155
Vacuum	3	344	295	227	253	251	1373
Total	26	3229	2427	2075	2296	2474	12527
Minus Nighttime	26	3093	2327	1913	2142	2338	11899

4 - Tool use by day for station lifetime (green = high / red = low)

	Sun	Mon	Tue	Wed	Thu	Fri	Sat	Total
Air	595	244	261	283	264	323	544	2514
Brush/Weed Hook	774	200	516	218	258	289	414	2669
Grabber	964	398	391	422	358	405	954	3892
Light	177	98	100	102	110	149	188	924
Plug Wrench	246	115	112	87	114	184	297	1155
Vacuum	270	183	142	133	133	213	299	1373
Total	3026	1238	1522	1245	1237	1563	2696	12527

5 - Key Insights

#	Metric	Value
1	Hour with Most Uses	8:00 PM
2	Day with Most Uses	Sunday
3	Day with 2 nd Most Uses	Saturday
4	Year with Most Uses	2018
5	Year with Least Uses *	2020

#	Metric	Value
6	Yearly Use Trend 21 to 22	Up
7	Tool with Most Uses	Grabber
8	Tool with Least Uses	Light
9	Significant Outliers Detected	YES

*2017 not included Sep start

Significant Outliers Detected

North Arm Mtka Wayside (b)



Metrics Menu

6 - Average daily tool use per month

	2017		2018						2019						2020					2021					2022											
	Sep	Oct	May	Jun	Jul	Aug	Sep	Oct	Apr	May	Jun	Jul	Aug	Sep	Oct	Jun	Jul	Aug	Sep	Oct	Mar	Apr	May	Jun	Jul	Aug	Sep	Oct	Apr	May	Jun	Jul	Aug	Sep	Oct	
Air	0	0	2	4	5	4	3	0	1	1	3	4	3	2	0	1	4	3	2	0	0	1	3	4	4	3	3	0	0	2	3	4	3	2	0	
Brush/Weed Hook	0	0	2	5	5	3	2	0	1	2	2	3	3	1	0	1	2	2	3	1	0	0	1	1	2	2	2	0	1	1	2	6	8	2	0	
Grabber	0	0	4	6	10	6	4	0	0	1	6	12	4	2	0	2	4	6	2	0	0	1	1	5	5	6	7	0	0	2	4	11	6	3	0	
Light	0	0	1	1	1	2	1	0	0	0	1	2	1	1	0	1	1	1	1	0	0	0	1	1	1	1	2	0	0	1	1	1	1	0	0	
Plug Wrench	0	0	3	3	3	2	1	0	1	1	2	1	1	1	0	1	0	1	1	0	0	0	1	1	1	1	2	0	0	1	1	3	1	0	0	
Vacuum	0	0	2	3	2	2	1	0	1	1	2	2	1	1	0	1	2	2	2	0	0	1	1	2	2	1	1	0	0	1	2	2	2	1	0	
Total	1	0	14	22	27	19	13	1	4	7	15	25	14	8	1	7	13	16	11	2	0	3	8	13	15	14	17	0	2	8	12	28	21	10	0	
Days in Month	30	31	31	30	31	31	30	31	30	31	30	31	31	30	31	30	31	31	30	31	31	30	31	30	31	30	31	30	31	30	31	31	30	31	30	31

7 - July 4th tool use per year

	2018	2019	2020	2021	2022	Total
Air	5	2	3	5	2	17
Brush/Weed Hook	7	1	1	3	0	12
Grabber	6	15	0	4	0	25
Light	2	1	0	1	1	5
Plug Wrench	7	2	0	1	0	10
Vacuum	1	2	0	1	0	4
Total	28	23	4	15	3	73

8 - Tool use by month per year (green = high / red = low)

	Mar	Apr	May	Jun	Jul	Aug	Sep	Oct	Total
2017							23	3	26
2018			442	673	823	579	378	334	3229
2019		112	230	436	768	426	250	205	2427
2020				199	394	502	340	640	2075
2021	12	94	249	380	453	447	508	153	2296
2022		47	241	370	855	653	291	17	2474
Total	12	253	1162	2058	3293	2607	1790	1352	12527

9 - Tool use by month per year trends

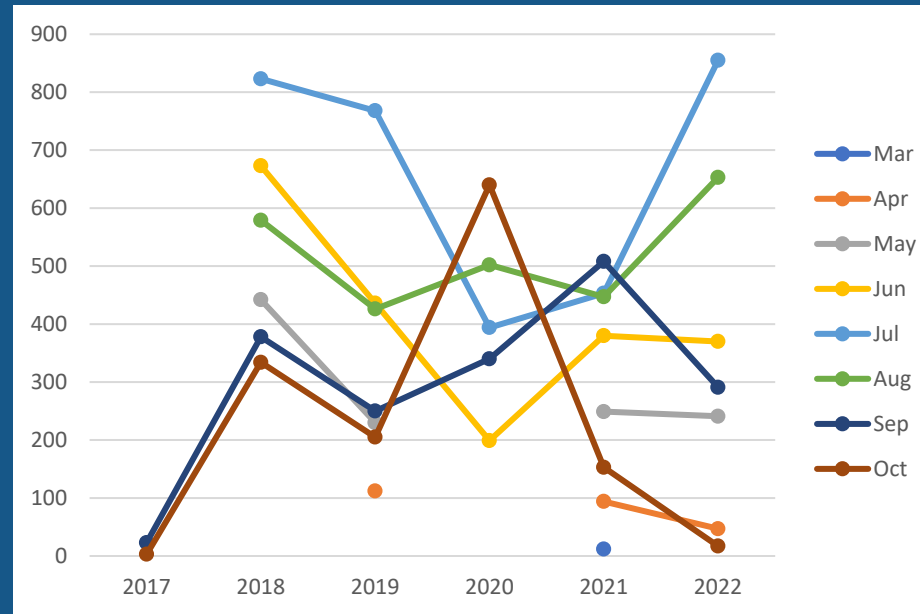

Long Wayside (a)



Metrics Menu

1 - Tool use by hour for station lifetime (green = high / red = low)

	12 AM	1 AM	2 AM	3 AM	4 AM	5 AM	6 AM	7 AM	8 AM	9 AM	10 AM	11 AM	12 PM	1 PM	2 PM	3 PM	4 PM	5 PM	6 PM	7 PM	8 PM	9 PM	10 PM	11 PM	Total
Air	16	3	1	470		1	4	18	15	119	106	143	396	119	153	165	292	182	334	354	245	167	38	9	3350
Brush/Weed Hook	3			122				4	7	19	18	22	40	20	15	37	44	29	27	38	43	14	3	1	506
Grabber	0	2	1	170	2		2	11	6	17	32	48	97	28	42	30	51	33	85	59	32	22	2	1	773
Light	8	7	1	185			3	7	3	31	22	24	42	28	27	26	43	38	36	46	56	71	21	6	731
Plug Wrench	6	2		176			1	12	6	45	35	43	74	33	42	53	102	51	89	91	69	28	8	3	969
Vacuum	7	3		322			2	11	30	136	82	117	177	100	86	112	155	84	127	164	132	67	12	8	1934
Total	40	17	3	1445	2	1	12	63	67	367	295	397	826	328	365	423	687	417	698	752	577	369	84	28	8263

2 - Yearly tool use for night time periods (green = low / red = high)

	12 AM	1 AM	2 AM	3 AM	4 AM	5 AM	6 AM	11 PM	Total
2018	1	2					3	9	15
2019	23		1	1	2		6	12	45
2020	7	1		784			1	4	797
2021	8	6		660		1	2	2	679
2022	1	8	2	0				1	12
Total	40	17	3	1445	2	1	12	28	1548

3 - Tool use by year (green = high / red = low)

	2018	2019	2020	2021	2022	Total
Air	500	732	768	841	509	3350
Brush/Weed Hook	80	168	121	103	34	506
Grabber	62	262	173	167	109	773
Light	144	210	177	161	39	731
Plug Wrench	210	284	188	196	91	969
Vacuum	349	564	494	274	253	1934
Total	1345	2220	1921	1742	1035	8263
Minus Nighttime	1330	1330	2175	1063	1023	6921

4 - Tool use by day for station lifetime (green = high / red = low)

	Sun	Mon	Tue	Wed	Thu	Fri	Sat	Total
Air	578	452	653	402	328	404	533	3350
Brush/Weed Hook	82	71	75	76	48	67	87	506
Grabber	136	111	149	96	89	96	96	773
Light	88	118	96	125	81	111	112	731
Plug Wrench	146	139	139	146	114	148	137	969
Vacuum	349	278	300	261	222	216	308	1934
Total	1379	1169	1412	1106	882	1042	1273	8263

5 - Key Insights

#	Metric	Value
1	Hour with Most Uses	3:00 AM
2	Day with Most Uses	Tuesday
3	Day with 2 nd Most Uses	Sunday
4	Year with Most Uses	2020
5	Year with Least Uses	2022

#	Metric	Value
6	Yearly Use Trend 21 to 22	Down
7	Tool with Most Uses	Air
8	Tool with Least Uses	Brush
9	Significant Outliers Detected	YES

Significant Outliers Detected

Long Wayside (b)



Metrics Menu

6 - Average daily tool use per month

	2018						2019						2020						2021						2022										
	Jun	Jul	Aug	Sep	Oct		Apr	May	Jun	Jul	Aug		Sep	Oct	Apr	May	Jun		Jul	Aug	Sep	Oct	Apr		May	Jun	Jul	Aug	Sep	Oct	Apr	May	Jul	Aug	Sep
Air	1	7	5	3	1		1	3	7	8	3	2	0		0	3	8	7	5	2	1		0	3	6	8	6	3	1		0	1	13	1	1
Brush/Weed Hook	0	1	1	1	0		0	1	2	2	1	0	0		0	1	1	1	1	0	0		0	1	1	1	0	0	0		0	0	1	0	0
Grabber	0	1	0	0	1		0	0	3	2	1	1	0		0	1	1	1	2	0	0		0	2	1	1	1	1	0		0	0	3	0	0
Light	0	2	1	1	0		0	2	2	2	1	1	0		0	1	1	2	1	1	0		0	1	1	1	1	1	0		0	0	1	0	0
Plug Wrench	0	3	2	1	0		0	2	3	2	1	0	0		0	1	2	1	1	0	0		0	1	1	2	1	1	0		0	0	2	0	0
Vacuum	1	3	4	2	1		1	2	4	4	3	3	1		0	2	4	4	4	1	0		0	2	2	4	1	0	0		1	1	5	0	1
Total	3	16	13	8	3		2	9	21	20	10	8	3		0	9	17	16	14	5	2		1	9	12	17	10	6	1		2	3	25	1	3
Days Per Month	30	31	31	30	31		30	31	30	31	31	30	31		30	31	30	31	31	30	31		30	31	30	31	31	30	31		30	31	30	31	31

7 - July 4th tool use per year

	2018	2019	2020	2021	Total
Air	4	20	14	14	52
Brush/Weed Hook	0	0	3	0	3
Grabber	1	1	1	0	3
Light	1	3	6	1	11
Plug Wrench	1	2	1	5	9
Vacuum	1	4	10	2	17
Total	8	30	35	22	95

8 - Tool use by month per year (green = high / red = low)

	Apr	May	Jun	Jul	Aug	Sep	Oct	Total
2018			79	510	418	240	98	1345
2019	69	285	617	621	308	236	84	2220
2020	13	270	508	510	432	136	52	1921
2021	42	292	369	512	317	169	41	1742
2022	59	98		751	38	89		1035
Total	183	945	1573	2904	1513	870	275	8263

9 - Tool use by month per year trends

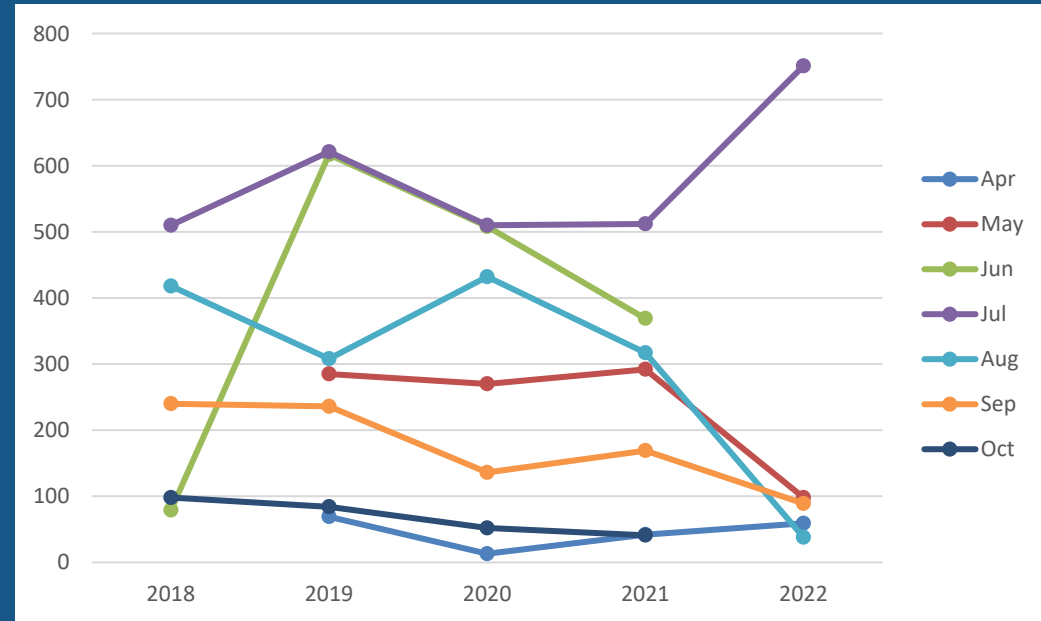

Bush Wayside (a)



Metrics Menu

1 - Tool use by hour for station lifetime (green = high / red = low)

	12 AM	1 AM	2 AM	3 AM	4 AM	5 AM	6 AM	7 AM	8 AM	9 AM	10 AM	11 AM	12 PM	1 PM	2 PM	3 PM	4 PM	5 PM	6 PM	7 PM	8 PM	9 PM	10 PM	11 PM	Total
Air	4	2	3	415	2	3	17	36	32	58	89	81	172	134	184	134	137	167	203	175	174	118	36		2376
Brush/Weed Hook	12			42	3				1	4	9	7	10	21	19	13	16	24	13	18	15	11	1		239
Grabber	9	3	5	141	13	4	3	2	13	23	18	58	61	54	58	55	136	43	35	72	68	77	4	3	958
Light	8	2	6	110	1		2	5	3	3	5	8	15	12	19	12	24	15	20	26	40	37	14	3	390
Plug Wrench	2	1	1	129	2	1	3		10	15	6	35	44	33	51	48	30	36	42	29	65	31	2		616
Vacuum	0		1	205	2	3	10	29	21	30	62	156	108	122	95	67	63	115	86	111	74	80	26		1466
Total	35	8	16	1042	23	11	35	72	80	133	189	345	410	376	426	329	406	400	399	431	436	354	83	6	6045

2 - Yearly tool use for night time periods (green = low / red = high)

	12 AM	1 AM	2 AM	3 AM	4 AM	5 AM	6 AM	11 PM	Total
2018		1					0		1
2019	26			156	22	1	3	2	210
2020	2		4	530	1	2	4		543
2021	4		4	343		4	9		364
2022	3	7	8	13		4	19	4	58
Total	35	8	16	1042	23	11	35	6	1176



3 - Tool use by year (green = high / red = low 2018 not included)

	2018	2019	2020	2021	2022	Total
Air	32	621	584	671	468	2376
Brush/Weed Hook	6	161	39	9	24	239
Grabber	196	285	165	120	192	958
Light	15	118	120	85	52	390
Plug Wrench	11	267	157	122	59	616
Vacuum	12	581	417	251	205	1466
Total	272	2033	1482	1258	1000	6045
Minus Nighttime	271	1823	939	894	942	4869

4 - Tool use by day for station lifetime (green = high / red = low)

	Sun	Mon	Tue	Wed	Thu	Fri	Sat	Total
Air	503	289	362	253	292	337	340	2376
Brush/Weed Hook	43	32	44	20	37	37	26	239
Grabber	213	103	112	159	106	193	72	958
Light	68	54	61	40	54	59	54	390
Plug Wrench	110	93	112	61	76	68	96	616
Vacuum	274	219	169	173	235	166	230	1466
Total	1211	790	860	706	800	860	818	6045

5 - Key Insights

#	Metric	Value
1	Hour with Most Uses	3:00 AM
2	Day with Most Uses	Sunday
3	Day with 2 nd Most Uses	Tuesday/Friday
4	Year with Most Uses	2019
5	Year with Least Uses	2022

#	Metric	Value
6	Yearly Use Trend 21 to 22	Down
7	Tool with Most Uses	Air
8	Tool with Least Uses	Light
9	Significant Outliers Detected	YES

*2018 not included



Significant Outliers Detected

Bush Wayside (b)



Metrics Menu

6 - Average daily tool use per month

	2018						2019						2020						2021						2022										
	Jun	Jul	Aug	Sep	Oct		Apr	May	Jun	Jul	Aug		Sep	Oct	Apr	May	Jun		Jul	Aug	Sep	Oct	Apr		May	Jun	Jul	Aug	Sep	Oct	Apr	May	Jun	Jul	Aug
Air	1	7	5	3	1		1	3	7	8	3	2	0		0	3	8	7	5	2	1		0	3	6	8	6	3	1		0	1	13	1	1
Brush/Weed Hook	0	1	1	1	0		0	1	2	2	1	0	0		0	1	1	1	1	0	0		0	1	1	1	0	0	0		0	0	1	0	0
Grabber	0	1	0	0	1		0	0	3	2	1	1	0		0	1	1	1	2	0	0		0	2	1	1	1	1	0		0	0	3	0	0
Light	0	2	1	1	0		0	2	2	2	1	1	0		0	1	1	2	1	1	0		0	1	1	1	1	1	0		0	0	1	0	0
Plug Wrench	0	3	2	1	0		0	2	3	2	1	0	0		0	1	2	1	1	0	0		0	1	1	2	1	1	0		0	0	2	0	0
Vacuum	1	3	4	2	1		1	2	4	4	3	3	1		0	2	4	4	4	1	0		0	2	2	4	1	0	0		1	1	5	0	1
Total	3	16	13	8	3		2	9	21	20	10	8	3		0	9	17	16	14	5	2		1	9	12	17	10	6	1		2	3	25	1	3
Days Per Month	30	31	31	30	31		30	31	30	31	31	30	31		30	31	30	31	31	30	31		30	31	30	31	31	30	31		30	31	30	31	31

7 - July 4th tool use per year

	2019	2020	2021	2022	Total
Air	5	0	3	6	14
Brush/Weed Hook	1	0	0	0	1
Grabber	0	0	2	1	3
Light	2	0	0	0	2
Plug Wrench	5	1	0	0	6
Vacuum	7	0	0	1	8
Total	20	1	5	8	34

8 - Tool use by month per year (green = high / red = low)

	Mar	Apr	May	Jun	Jul	Aug	Sep	Oct	Total
2018							42	230	272
2019		112	295	475	408	324	244	175	2033
2020		0	109	284	316	526	194	53	1482
2021	18	77	252	320	352	135	90	14	1258
2022		91	197	384	328				1000
Total	18	280	853	1463	1404	985	570	472	6045

9 - Tool use by month per year trends

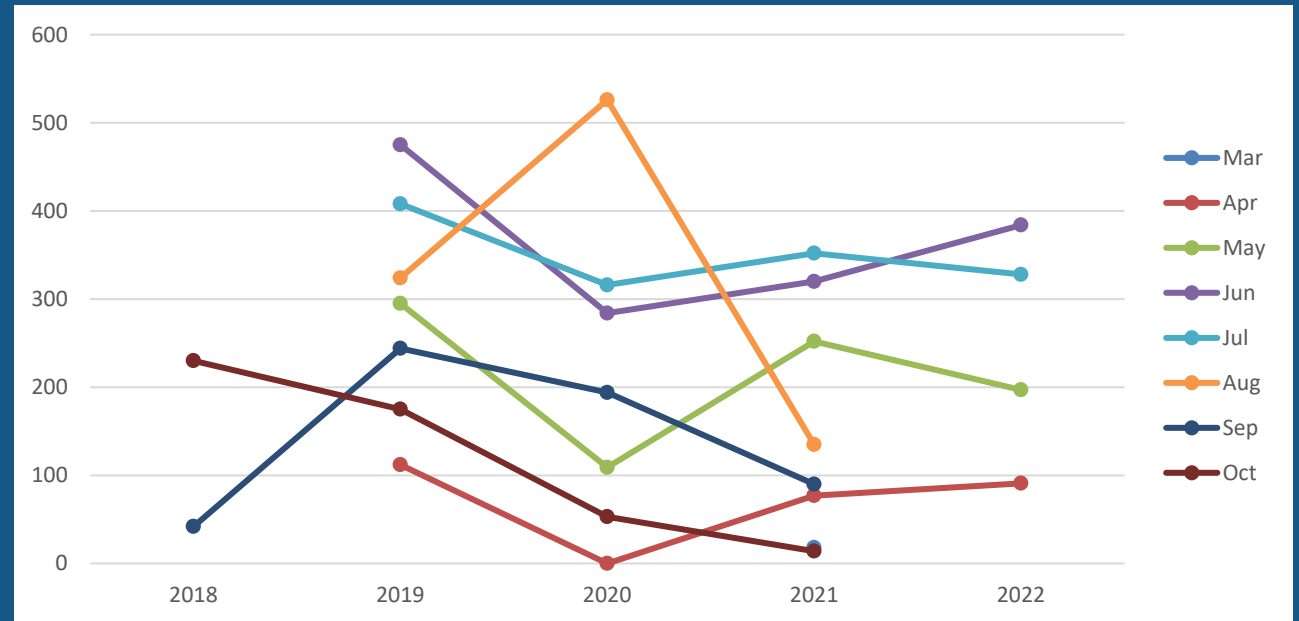

Champlin Park (a)



Metrics Menu

1 - Tool use by hour for station lifetime (green = high / red = low)

	12 AM	1 AM	3 AM	4 AM	5 AM	6 AM	7 AM	8 AM	9 AM	10 AM	11 AM	12 PM	1 PM	2 PM	3 PM	4 PM	5 PM	6 PM	7 PM	8 PM	9 PM	10 PM	11 PM	Total
Air	6		42		4		1	3	3	3	1	1	9	16	9	13	37	64	49	5	7	1		274
Brush/Weed Hook	1		38	1				0	5	0		2	1	3	4	2	2	2	7	1				69
Grabber	3	2	30		1	1	1	1	3	1			1	3	5	4	18	22	9	3		1		109
Light			18		1	1		2	0	2	1		2	1			1	6	10	2	4	1		52
Plug Wrench	2		31				3	3	4	1	1		4	9	6	9	14	49	19	2	1	1	1	160
Vacuum	2		50				1	0	2	1	3	2	4	10	5	3	13	13	17	2	3			131
Total	14	2	209	1	6	2	6	9	17	8	6	5	21	42	29	31	85	156	111	15	15	4	1	795

2 - Yearly tool use for night time periods (green = low / red = high)

	12 AM	1 AM	3 AM	4 AM	5 AM	6 AM	11 PM	Total
2021	11	2	206	1	6	2	1	229
2022	3		3					6
Total	14	2	209	1	6	2	1	235

3 - Tool use by year (green = high / red = low)

	2021	2022	Total
Air	222	52	274
Brush/Weed Hook	63	6	69
Grabber	77	32	109
Light	39	13	52
Plug Wrench	129	31	160
Vacuum	104	27	131
Total	634	161	795
Minus Nighttime	405	155	560

4 - Tool use by day for station lifetime (green = high / red = low)

	Sun	Mon	Tue	Wed	Thu	Fri	Sat	Total
Air	72	36	19	21	26	39	61	274
Brush/Weed Hook	12	7	3	2	5	34	6	69
Grabber	21	28	12	10	5	12	21	109
Light	7	10	4	10	4	11	6	52
Plug Wrench	27	39	26	12	10	14	32	160
Vacuum	27	19	11	14	14	17	29	131
Total	166	139	75	69	64	127	155	795

5 - Key Insights

#	Metric	Value
1	Hour with Most Uses	3:00 AM
2	Day with Most Uses	Sunday
3	Day with 2 nd Most Uses	Saturday
4	Year with Most Uses	2021
5	Year with Least Uses	2022

#	Metric	Value
6	Yearly Use Trend 21 to 22	Down
7	Tool with Most Uses	Air
8	Tool with Least Uses	Light
9	Significant Outliers Detected	YES

*2018 not included

Significant Outliers Detected

Champlin Park (b)



Metrics Menu

6 - Average daily tool use per month

	2021					2022		
	Aug	Sep	Oct	Nov		Apr	May	Jun
Air	1	3	3	0		0	1	0
Brush/Weed Hook	0	1	1	0		0	0	0
Grabber	1	1	1	0		0	1	0
Light	0	0	1	0		0	0	0
Plug Wrench	1	2	1	0		0	1	0
Vacuum	1	2	1	0		0	1	0
Total	4	9	7	0		1	4	0
Days in Month	31	30	31	30		30	31	30

7 - July 4th tool use per year

No July 4th usage recorded

8 - Tool use by month per year (green = high / red = low)

	Apr	May	Jun	Aug	Sep	Oct	Nov	Total
2021				137	273	224	0	634
2022	17	133	11					161
Total	17	133	11	137	273	224	0	795

9 - Tool use by month per year trends

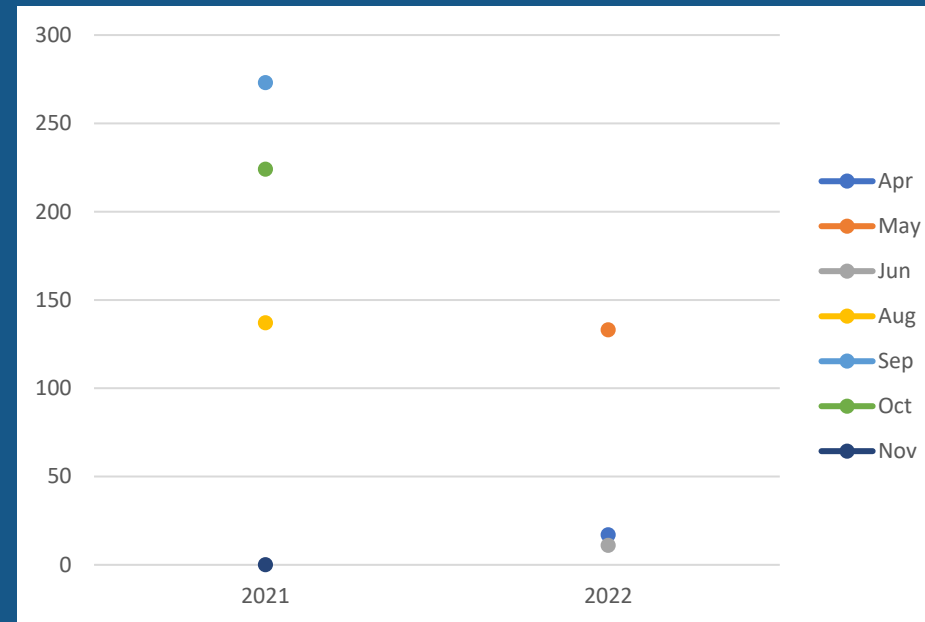

Riverside Mississippi Wayside (a)



Metrics Menu

1 - Tool use by hour for station lifetime (green = high / red = low)

	12 AM	1 AM	2 AM	3 AM	4 AM	5 AM	6 AM	7 AM	8 AM	9 AM	10 AM	11 AM	12 PM	1 PM	2 PM	3 PM	4 PM	5 PM	6 PM	7 PM	8 PM	9 PM	10 PM	11 PM	Total
Air				71			4	4	5	7	13	17	14	8	18	28	19	22	31	24	31	13	2	4	335
Brush/Weed Hook		2	1	22		3	8	5	11	2	6	8	24	23	12	23	6	12	17	1	13	1	1	1	202
Grabber		2	3	47	3	3	3	2	5	3	11	13	17	16	20	10	10	13	12	11	10	6	2	1	223
Light				28				1	2		1	2		0	6	2	4	4	4	10	7	9	1	2	83
Plug Wrench				31		1		1	1	4	5	5	6	4	6	4	5	13	9	13	7	4	1	1	121
Vacuum	1			91					7	2	11	12	18	12	36	25	23	30	30	27	43	8	3	1	380
Total	1	4	4	290	3	7	15	13	31	18	47	57	79	63	98	92	67	94	103	86	111	41	10	10	1344



2 - Yearly tool use for night time periods (green = low / red = high)

	12 AM	1 AM	2 AM	3 AM	4 AM	5 AM	6 AM	11 PM	Total
2021			2	215	2	2	4	3	228
2022	1	4	2	75	1	5	11	7	106
Total	1	4	4	290	3	7	15	10	334



3 - Tool use by year (green = high / red = low)

	2021	2022	Total
Air	192	143	335
Brush/Weed Hook	25	177	202
Grabber	128	95	223
Light	47	36	83
Plug Wrench	69	52	121
Vacuum	164	216	380
Total	625	719	1344
Minus Nighttime	397	613	1010

4 - Tool use by day for station lifetime (green = high / red = low)

	Sun	Mon	Tue	Wed	Thu	Fri	Sat	Total
Air	62	32	49	37	41	51	63	335
Brush/Weed Hook	55	6	5	20	4	13	99	202
Grabber	30	19	36	28	40	32	38	223
Light	16	11	6	10	4	12	24	83
Plug Wrench	16	13	16	15	10	16	35	121
Vacuum	76	45	37	38	46	42	96	380
Total	255	126	149	148	145	166	355	1344

5 - Key Insights

#	Metric	Value
1	Hour with Most Uses	3:00 AM
2	Day with Most Uses	Saturday
3	Day with 2 nd Most Uses	Sunday
4	Year with Most Uses	2022
5	Year with Least Uses	2021

#	Metric	Value
6	Yearly Use Trend 21 to 22	UP
7	Tool with Most Uses	Vacuum
8	Tool with Least Uses	Light
9	Significant Outliers Detected	YES

*2018 not included

Significant Outliers Detected

Riverside Mississippi Wayside (b)



Metrics Menu

6 - Average daily tool use per month

	2021							2022							
	Jun	Jul	Aug	Sep	Oct	Nov	Dec	Mar	Apr	May	Jun	Jul	Aug	Sep	Oct
Air	1	3	1	1	1	0	0	0	0	1	1	1	1	1	0
Brush/Weed Hook	0	1	0	0	0	0	0	0	4	2	0	0	0	0	0
Grabber	0	1	0	0	1	1	0	0	0	1	1	0	0	0	0
Light	0	1	0	0	0	0	0	0	0	0	0	0	0	0	0
Plug Wrench	0	1	0	0	0	0	0	0	0	0	0	0	0	0	0
Vacuum	1	1	2	1	1	0	0	0	0	2	2	1	1	1	0
Total	2	7	4	3	3	1	0	0	5	5	5	3	3	2	0
Days in Month	30	31	30	30	31	30	31	31	30	31	30	31	31	30	31

7 - July 4th tool use per year

	2021	2022	Total
Air	1	1	2
Brush/Weed Hook	0	0	0
Grabber	0	0	0
Light	0	0	0
Plug Wrench	0	0	0
Vacuum	0	2	2
Total	1	3	4

8 - Tool use by month per year (green = high / red = low)

	Mar	Apr	May	Jun	Jul	Aug	Sep	Oct	Nov	Dec	Total
2021				61	221	123	94	90	35	1	625
2022	6	141	161	160	108	78	65	0			719
Total	6	141	161	221	329	201	159	90	35	1	1344

9 - Tool use by month per year trends

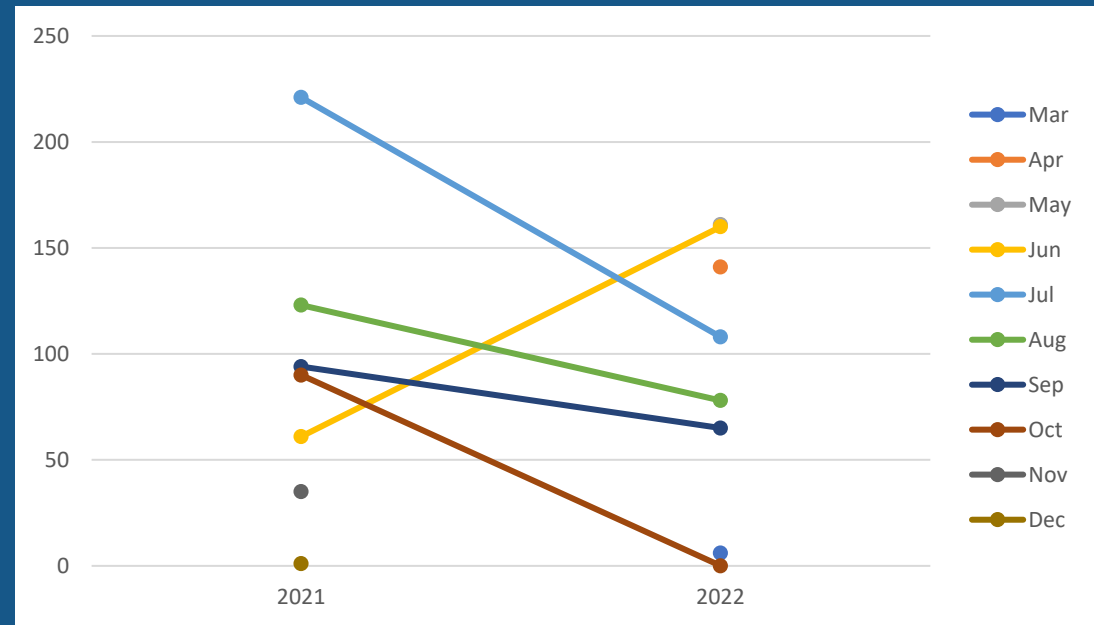

Hennepin Station Specific CD3 Usage Metrics

Trailer Stations

CD3 Usage Metrics Trailer Menu

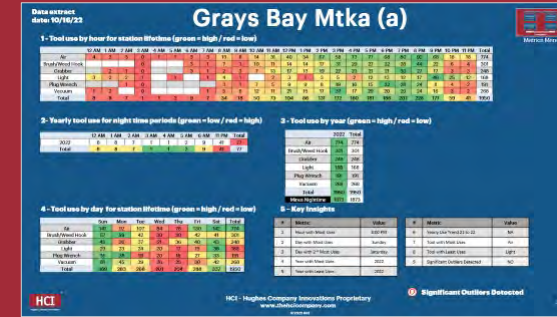
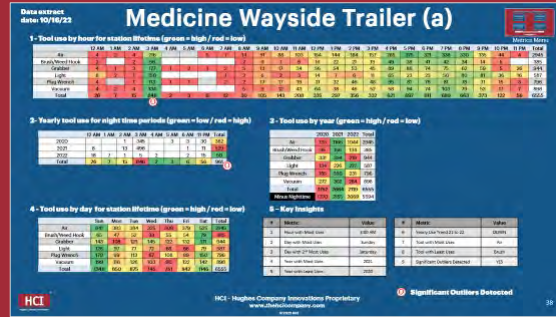

Click Buttons to Navigate to CD3 Location Metrics

Medicine Wayside Trailer (a)



Metrics Menu

1 - Tool use by hour for station lifetime (green = high / red = low)

	12 AM	1 AM	2 AM	3 AM	4 AM	5 AM	6 AM	7 AM	8 AM	9 AM	10 AM	11 AM	12 PM	1 PM	2 PM	3 PM	4 PM	5 PM	6 PM	7 PM	8 PM	9 PM	10 PM	11 PM	Total
Air	4	2	4	216			5	7	14	51	88	103	154	144	184	157	265	375	321	338	330	135	44	4	2945
Brush/Weed Hook	2		2	56					2	9	7	6	16	22	21	19	49	38	41	42	34	14	5		385
Grabber	4	1	3	177	1	2	1	2	5	13	17	34	56	54	53	45	89	86	74	75	62	59	5	26	944
Light	8	2	1	150				1	2	6	2	3	14	7	6	11	65	23	23	50	80	81	36	16	587
Plug Wrench	4		1	113	1	1		2	2	17	17	19	31	32	46	48	95	81	78	81	78	31	15	3	796
Vacuum	4	2	4	134					5	9	12	43	64	38	46	52	58	94	74	103	79	53	17	7	898
Total	26	7	15	846	2	3	6	12	30	105	143	208	335	297	356	332	621	697	611	689	663	373	122	56	6555



2 - Yearly tool use for night time periods (green = low / red = high)

	12 AM	1 AM	2 AM	3 AM	4 AM	5 AM	6 AM	11 PM	Total
2020			1	345		3	3	30	382
2021	8		13	496			1	11	529
2022	18	7	1	5	2		2	15	50
Total	26	7	15	846	2	3	6	56	961



3 - Tool use by year (green = high / red = low)

	2020	2021	2022	Total
Air	735	1166	1044	2945
Brush/Weed Hook	95	156	134	385
Grabber	331	394	219	944
Light	134	226	227	587
Plug Wrench	185	380	231	796
Vacuum	272	362	264	898
Total	1752	2684	2119	6555
Minus Nighttime	1370	2155	2069	5594

4 - Tool use by day for station lifetime (green = high / red = low)

	Sun	Mon	Tue	Wed	Thu	Fri	Sat	Total
Air	641	383	384	325	308	379	525	2945
Brush/Weed Hook	65	47	52	33	55	54	79	385
Grabber	143	108	123	145	122	132	171	944
Light	128	97	77	72	68	66	79	587
Plug Wrench	170	99	113	67	108	89	150	796
Vacuum	199	116	126	103	90	122	142	898
Total	1346	850	875	745	751	842	1146	6555

5 - Key Insights

#	Metric	Value
1	Hour with Most Uses	3:00 AM
2	Day with Most Uses	Sunday
3	Day with 2 nd Most Uses	Saturday
4	Year with Most Uses	2021
5	Year with Least Uses	2020

#	Metric	Value
6	Yearly Use Trend 21 to 22	DOWN
7	Tool with Most Uses	Air
8	Tool with Least Uses	Brush
9	Significant Outliers Detected	YES

Significant Outliers Detected

Medicine Wayside Trailer (b)



Metrics Menu

6 - Average daily tool use per month

	2020				2021									2022							
	Jul	Aug	Sep	Oct	Apr	May	Jun	Jul	Aug	Sep	Oct	Nov	Dec	Mar	Apr	May	Jun	Jul	Aug	Sep	Oct
Air	8	7	5	4	1	6	10	8	5	6	2	0	0	0	0	3	8	9	8	5	2
Brush/Weed Hook	1	1	1	1	0	1	1	1	0	1	1	0	0	0	0	0	1	1	1	1	0
Grabber	1	2	2	6	0	2	3	2	2	2	2	0	0	0	0	1	2	2	2	1	0
Light	1	1	1	1	0	1	1	1	2	1	1	0	0	0	0	1	2	1	2	1	0
Plug Wrench	2	1	2	1	1	2	3	2	2	2	2	0	0	0	0	1	2	2	1	1	0
Vacuum	2	3	2	1	0	1	2	3	2	2	1	0	0	0	0	1	3	2	1	1	1
Total	15	15	12	14	3	13	20	18	14	12	7	0	0	0	0	7	17	16	15	10	3
Days in Month	31	31	30	31	30	31	30	31	31	30	31	30	31	31	30	31	30	31	31	30	31

7 - July 4th tool use per year

	2020	2021	2022	Total
Air	9	22	15	46
Brush/Weed Hook	2	1	2	5
Grabber	0	4	3	7
Light	1	3	7	11
Plug Wrench	0	2	7	9
Vacuum	0	7	4	11
Total	12	39	38	89

8 - Tool use by month per year (green = high / red = low)

	Mar	Apr	May	Jun	Jul	Aug	Sep	Oct	Nov	Dec	Total
2020					465	480	371	436			1752
2021		91	399	601	572	424	368	228	1	0	2684
2022	2	0	210	523	501	469	310	104			2119
Total	2	91	609	1124	1538	1373	1049	768	1	0	6555

9 - Tool use by month per year trends

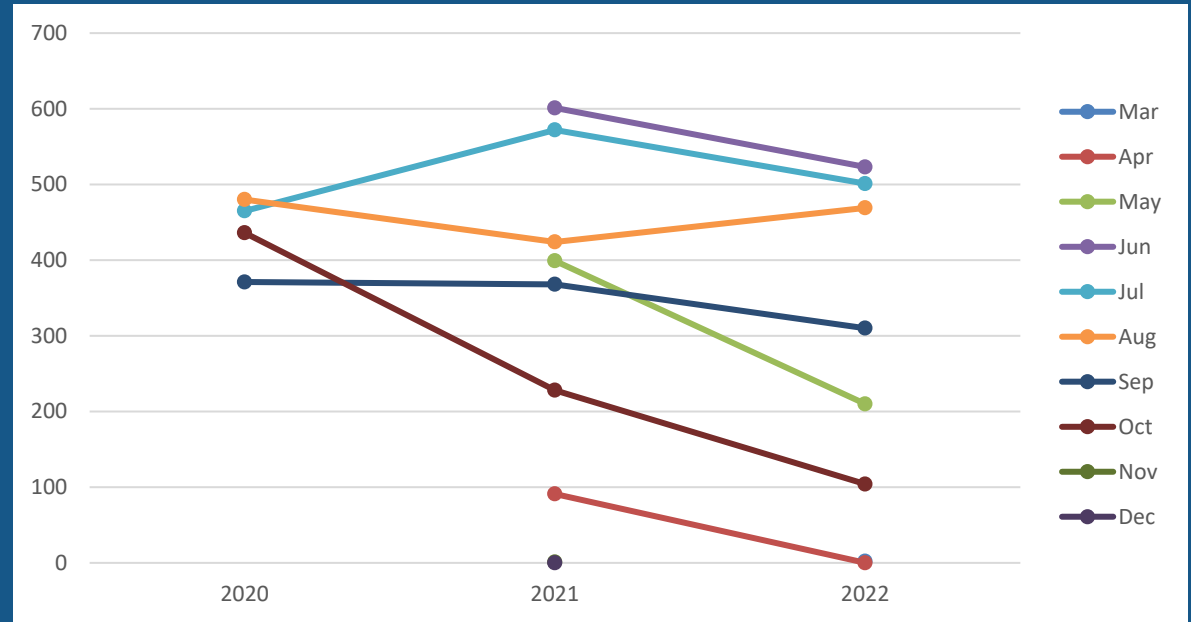

Grays Bay Mtka (a)



Metrics Menu

1 - Tool use by hour for station lifetime (green = high / red = low)

	12 AM	1 AM	2 AM	3 AM	4 AM	5 AM	6 AM	7 AM	8 AM	9 AM	10 AM	11 AM	12 PM	1 PM	2 PM	3 PM	4 PM	5 PM	6 PM	7 PM	8 PM	9 PM	10 PM	11 PM	Total
Air	4	2	3	0	1	1	3	3	13	6	14	31	40	34	67	58	73	77	68	80	92	68	18	18	774
Brush/Weed Hook				0			3	1	7	1	10	11	14	14	17	31	29	27	32	28	44	22	6	4	301
Grabber		2	1	0			3	1	2	3	7	13	17	13	19	22	23	21	21	30	27	17	3	3	248
Light	3	2	2	1		1		1	4	1		2	3	1	3	5	2	12	13	12	17	46	25	12	168
Plug Wrench			1	0					3	1	7	5	9	9	8	19	16	15	32	28	24	8	4	2	191
Vacuum	1	2		0				1	5	6	12	11	21	15	17	37	17	29	20	29	24	16	3	2	268
Total	8	8	7	1	1	2	9	7	34	18	50	73	104	86	131	172	160	181	186	207	228	177	59	41	1950

2 - Yearly tool use for night time periods (green = low / red = high)

	12 AM	1 AM	2 AM	3 AM	4 AM	5 AM	6 AM	11 PM	Total
2022	8	8	7	1	1	2	9	41	77
Total	8	8	7	1	1	2	9	41	77

3 - Tool use by year (green = high / red = low)

	2022	Total
Air	774	774
Brush/Weed Hook	301	301
Grabber	248	248
Light	168	168
Plug Wrench	191	191
Vacuum	268	268
Total	1950	1950
Minus Nighttime	1873	1873

4 - Tool use by day for station lifetime (green = high / red = low)

	Sun	Mon	Tue	Wed	Thu	Fri	Sat	Total
Air	141	92	107	84	78	130	142	774
Brush/Weed Hook	57	59	42	30	30	42	41	301
Grabber	45	26	37	21	36	40	43	248
Light	29	23	24	20	17	19	36	168
Plug Wrench	36	38	19	20	18	27	33	191
Vacuum	61	45	39	26	25	30	42	268
Total	369	283	268	201	204	288	337	1950

5 - Key Insights

#	Metric	Value
1	Hour with Most Uses	8:00 PM
2	Day with Most Uses	Sunday
3	Day with 2 nd Most Uses	Saturday
4	Year with Most Uses	2022
5	Year with Least Uses	2022

#	Metric	Value
6	Yearly Use Trend 21 to 22	NA
7	Tool with Most Uses	Air
8	Tool with Least Uses	Light
9	Significant Outliers Detected	NO

Significant Outliers Detected

Grays Bay Mtka (b)



Metrics Menu

6 - Average daily tool use per month

	2022						
	Apr	May	Jun	Jul	Aug	Sep	Oct
Air	1	3	6	7	6	2	1
Brush/Weed Hook	0	1	2	2	3	1	1
Grabber	0	1	2	2	3	0	0
Light	0	1	1	2	2	0	0
Plug Wrench	0	1	1	2	1	0	0
Vacuum	0	2	2	2	2	0	0
Total	2	8	13	17	16	4	3
Days in Month	30	31	30	31	31	30	31

7 - July 4th tool use per year

	2022	Total
Air	11	11
Brush/Weed Hook	4	4
Grabber	2	2
Light	1	1
Plug Wrench	0	0
Vacuum	1	1
Total	19	19

8 - Tool use by month per year (green = high / red = low)

	Apr	May	Jun	Jul	Aug	Sep	Oct	Total
2022	50	249	399	512	506	128	106	1950
Total	50	249	399	512	506	128	106	1950

9 - Tool use by month per year trends

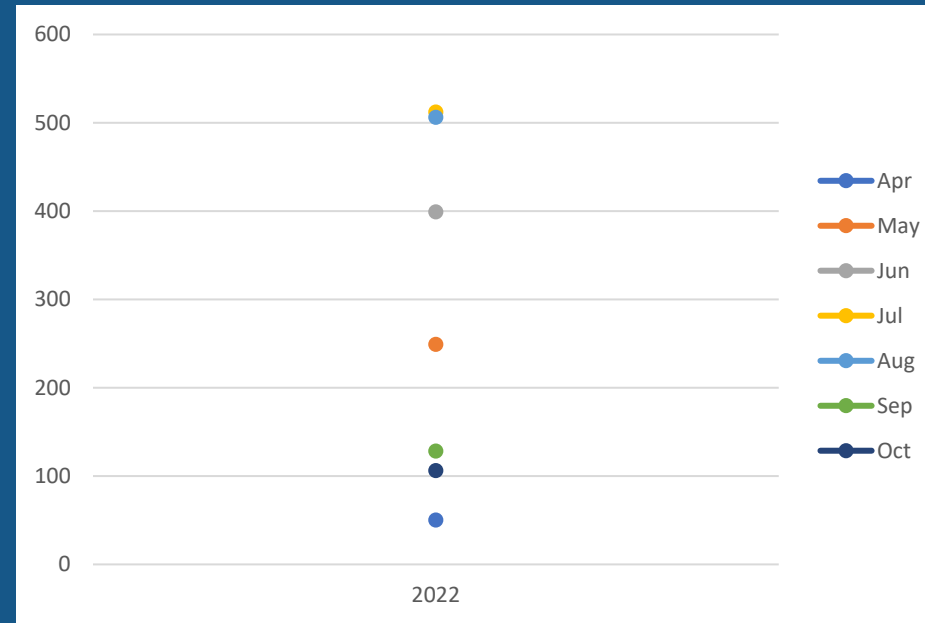

Hennepin Station Specific CD3 Usage Metrics

Outpost Stations

Spring Park Outpost 1 (a)



Metrics Menu

1 - Tool use by hour for station lifetime (green = high / red = low)

	12 AM	1 AM	2 AM	3 AM	4 AM	5 AM	6 AM	7 AM	8 AM	9 AM	10 AM	11 AM	12 PM	1 PM	2 PM	3 PM	4 PM	5 PM	6 PM	7 PM	8 PM	9 PM	10 PM	11 PM	Total
Brush/Weed Hook	3	14	5	7	22	25	23	64	55	22	21	73	31	70	47	39	123	92	96	71	97	15	30	9	1054
Grabber	5	12	7	3	16	24	3	4	16	30	14	25	34	26	40	77	76	77	86	95	107	27	29	7	840
Light	1	2	2	0	1			2	1	0	5	6	5	2	3	8	7	12	12	19	20	14	11	2	135
Plug Wrench	3	7	8	7	30	7	6	9	6	13	30	29	30	35	48	60	58	91	68	92	59	53	26	8	783
Total	12	35	22	17	69	56	32	79	78	65	70	133	100	133	138	184	264	272	262	277	283	109	96	26	2812

2- Yearly tool use for night time periods (green = low / red = high)

	12 AM	1 AM	2 AM	3 AM	4 AM	5 AM	6 AM	11 PM	Total
2018	5	6	15		19	35	4	4	88
2019	4	13	3	4	18	1	3	1	47
2020	3	7	4	8	30	3	7	12	74
2021		9		4	1	16	17	8	55
2022				1	1	1	1	1	5
Total	12	35	22	17	69	56	32	26	269

3 - Tool use by year (green = high / red = low / 2018 not included)

s	2018	2019	2020	2021	2022	Total
Brush/Weed Hook	89	218	365	279	103	1054
Grabber	168	325	132	120	95	840
Light	21	40	50	16	8	135
Plug Wrench	138	235	267	81	62	783
Total	416	818	814	496	268	2812
Minus Nighttime	328	771	740	441	263	2543

4 - Tool use by day for station lifetime (green = high / red = low)

	Sun	Mon	Tue	Wed	Thu	Fri	Sat	Total
Brush/Weed Hook	238	114	137	287	55	76	147	1054
Grabber	267	59	60	101	57	89	207	840
Light	24	20	9	17	14	14	37	135
Plug Wrench	172	81	55	171	92	90	122	783
Total	701	274	261	576	218	269	513	2812

5 - Key Insights

#	Metric	Value
1	Hour with Most Uses	8:00 PM
2	Day with Most Uses	Sunday
3	Day with 2 nd Most Uses	Wednesday
4	Year with Most Uses	2020
5	Year with Least Uses	2022

#	Metric	Value
6	Yearly Use Trend 21 to 22	Down
7	Tool with Most Uses	Brush
8	Tool with Least Uses	Light
9	Significant Outliers Detected	YES

*2018 not included

Significant Outliers Detected

Spring Park Outpost 1 (b)



Metrics Menu

6 - Average daily tool use per month

	2018		2019							2020					2021				2022					
	Sep	Oct	Apr	May	Jun	Jul	Aug	Sep	Oct	Jun	Jul	Aug	Sep	Oct	Mar	Apr	May	Jun	Apr	May	Jun	Aug	Sep	Oct
Brush/Weed Hook	1	2	0	1	1	1	2	1	2	0	2	2	7	1	0	0	8	1	1	1	0	0	1	0
Grabber	2	4	0	1	2	1	2	3	1	0	1	1	1	1	0	0	1	3	1	1	0	0	1	0
Light	0	0	0	0	0	0	0	0	0	0	1	1	0	0	0	0	0	0	0	0	0	0	0	0
Plug Wrench	1	3	0	2	2	1	1	1	1	0	2	1	2	4	1	1	1	1	1	1	0	0	0	0
Total	4	10	1	4	5	4	5	5	3	0	6	5	10	6	1	1	10	4	2	2	1	0	2	0
Days in Month	30	31	30	31	30	31	31	30	31	30	31	30	31	31	31	30	31	30	30	30	31	31	31	30

7 - July 4th tool use per year

	2019	2020	2021	2022	Total
Brush/Weed Hook	20	1	0	0	21
Grabber	9	0	0	0	9
Light	0	0	0	0	0
Plug Wrench	8	1	0	0	9
Total	37	2	0	0	39

8 - Tool use by month per year (green = high / red = low)

	Mar	Apr	May	Jun	Jul	Aug	Sep	Oct	Total
2018							112	304	416
2019		20	128	158	110	162	148	92	818
2020				2	182	156	303	171	814
2021	20	29	313	134					496
2022		74	74	28		15	72	5	268
Total	20	123	515	322	292	333	635	572	2812

9 - Tool use by month per year trends

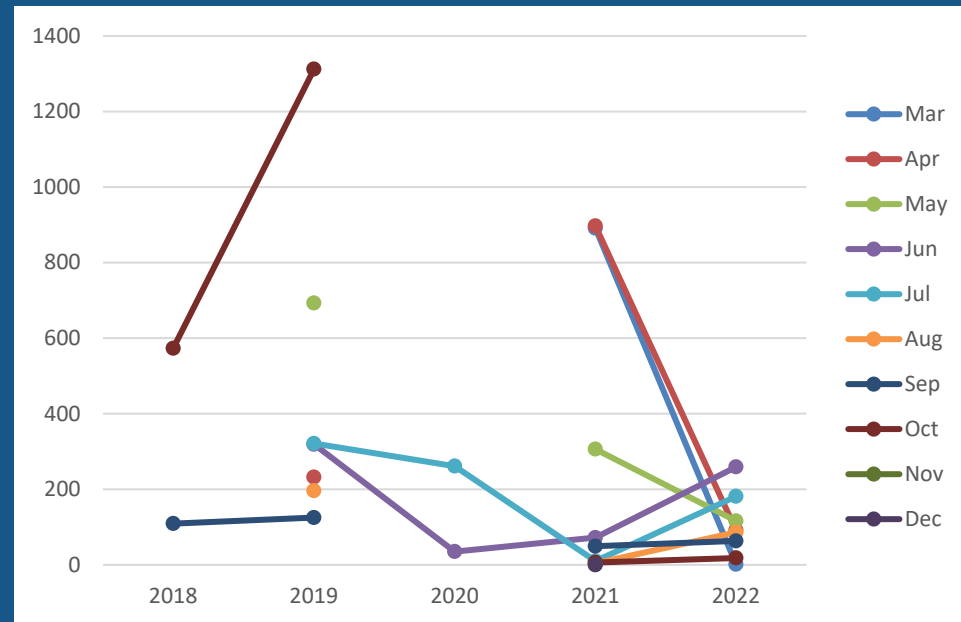

Spring Park Outpost 2 (a)



Metrics Menu

1 - Tool use by hour for station lifetime (green = high / red = low)

	12 AM	1 AM	2 AM	3 AM	4 AM	5 AM	6 AM	7 AM	8 AM	9 AM	10 AM	11 AM	12 PM	1 PM	2 PM	3 PM	4 PM	5 PM	6 PM	7 PM	8 PM	9 PM	10 PM	11 PM	Total
Brush/Weed Hook	73	113	138	90	60	40	98	46	157	300	387	394	401	501	438	415	472	430	367	156	136	133	23	45	5413
Grabber	3	4	10	74	86	127	130	39	27	22	32	24	52	27	68	46	52	47	45	60	26	19	1	3	1024
Light	1	1	1	1	0	0	0	0	2	1	4	3	3	6	4	1	7	8	6	7	12	17	3	3	91
Plug Wrench	1	0	1	8	15	1	14	23	12	10	22	37	38	44	44	47	82	61	85	59	50	39	1	4	698
Total	78	118	150	173	161	168	242	108	198	333	445	458	494	578	554	509	613	546	503	282	224	208	28	55	7226

2 - Yearly tool use for night time periods (green = low / red = high)

	12 AM	1 AM	2 AM	3 AM	4 AM	5 AM	6 AM	11 PM	Total
2018	3	4	9	50	97	125	173	1	462
2019	75	114	138	119	60	35	65	47	653
2020				0				3	3
2021							0		0
2022			3	4	4	8	4	4	27
Total	78	118	150	173	161	168	242	55	1145

3 - Tool use by year (green = high / red = low 2018 not included)

	2018	2019	2020	2021	2022	Total
Brush/Weed Hook	66	2382	234	2141	590	5413
Grabber	529	495	0	0	0	1024
Light	6	48	12	0	25	91
Plug Wrench	81	273	50	94	200	698
Total	682	3198	296	2235	815	7226
Minus Nighttime	220	2545	293	2235	788	6081

4 - Tool use by day for station lifetime (green = high / red = low)

	Sun	Mon	Tue	Wed	Thu	Fri	Sat	Total
Brush/Weed Hook	731	738	1736	901	575	310	422	5413
Grabber	606	72	92	22	60	67	105	1024
Light	17	14	9	10	9	15	17	91
Plug Wrench	203	72	75	65	49	68	166	698
Total	1557	896	1912	998	693	460	710	7226

5 - Key Insights

#	Metric	Value
1	Hour with Most Uses	4:00 PM
2	Day with Most Uses	Sunday
3	Day with 2 nd Most Uses	Tuesday
4	Year with Most Uses	2019
5	Year with Least Uses	2020

#	Metric	Value
6	Yearly Use Trend 21 to 22	Down
7	Tool with Most Uses	Brush
8	Tool with Least Uses	Light
9	Significant Outliers Detected	YES

*2018 not included

Significant Outliers Detected

Spring Park Outpost 2 (b)



Metrics Menu

6 - Average daily tool use per month

	2018		2019							2020					2021				2022					
	Sep	Oct	Apr	May	Jun	Jul	Aug	Sep	Oct	Jun	Jul	Aug	Sep	Oct	Mar	Apr	May	Jun	Apr	May	Jun	Aug	Sep	Oct
Brush/Weed Hook	1	2	0	1	1	1	2	1	2	0	2	2	7	1	0	0	8	1	1	1	0	0	1	0
Grabber	2	4	0	1	2	1	2	3	1	0	1	1	1	1	0	0	1	3	1	1	0	0	1	0
Light	0	0	0	0	0	0	0	0	0	0	1	1	0	0	0	0	0	0	0	0	0	0	0	0
Plug Wrench	1	3	0	2	2	1	1	1	1	0	2	1	2	4	1	1	1	1	1	1	0	0	0	0
Total	4	10	1	4	5	4	5	5	3	0	6	5	10	6	1	1	10	4	2	2	1	0	2	0
Days in Month	30	31	30	31	30	31	31	30	31	30	31	30	31	31	31	30	31	30	30	30	31	31	31	30

7 - July 4th tool use per year

	2019	2020	Total
Brush/Weed Hook	0	0	0
Grabber	1	5	6
Light	0	0	0
Plug Wrench	0	1	1
Total	1	6	7

8 - Tool use by month per year (green = high / red = low) *

	Mar	Apr	May	Jun	Jul	Aug	Sep	Oct	Total
2018							112	304	416
2019		20	128	158	110	162	148	92	818
2020				2	182	156	303	171	814
2021	20	29	313	134					496
2022		74	74	28		15	72	5	268
Total	20	123	515	322	292	333	635	572	2812

9 - Tool use by month per year trends

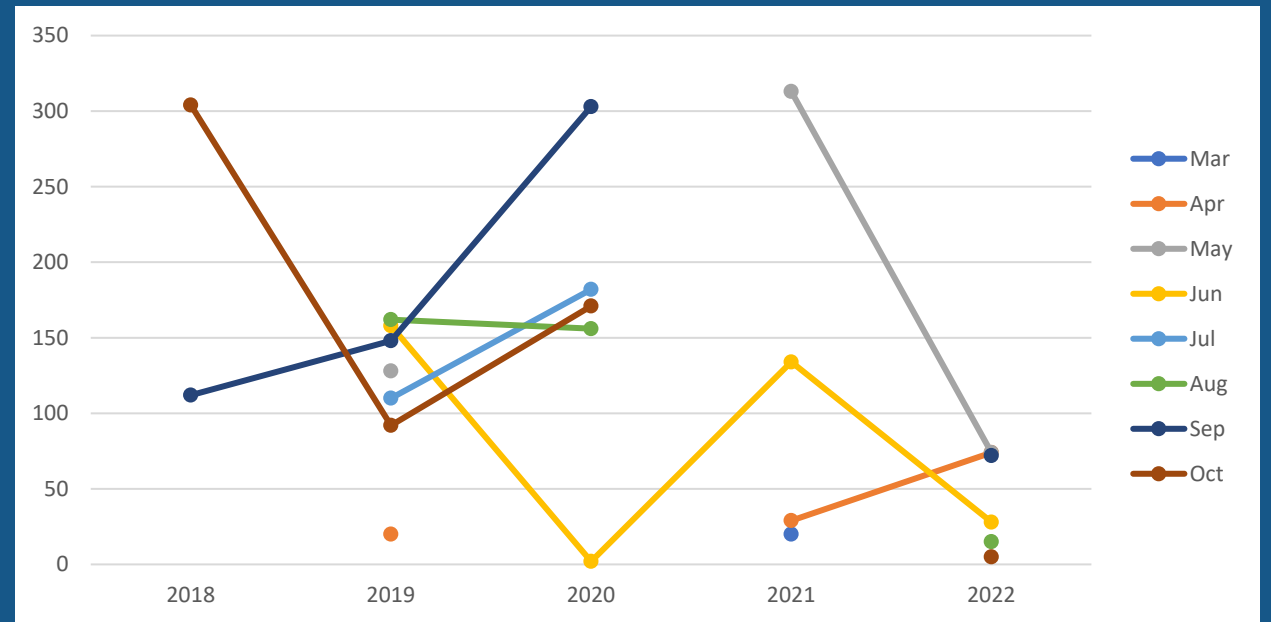

Fish Lake Outpost (a)



Metrics Menu

1 - Tool use by hour for station lifetime (green = high / red = low)

	12 AM	1 AM	2 AM	3 AM	4 AM	6 AM	7 AM	8 AM	9 AM	10 AM	11 AM	12 PM	1 PM	2 PM	3 PM	4 PM	5 PM	6 PM	7 PM	8 PM	9 PM	10 PM	11 PM	Total
Brush/Weed Hook	1		1	762	1	1	2	7	15	27	256	34	44	35	35	27	33	304	42	39	15	5	2	1688
Grabber				863		1	1	1	9	5	261	19	28	29	42	34	60	50	55	53	11			1522
Light		1		191				1	2	2	47	6	7	6	9	9	12	13	21	31	22	3		383
Plug Wrench		1	1	799		2	2	2	16	31	185	36	42	35	48	37	57	68	144	59	19	1	3	1588
Total	1	2	2	2615	1	4	5	11	42	65	749	95	121	105	134	107	162	435	262	182	67	9	5	5181

2- Yearly tool use for night time periods (green = low / red = high)

	12 AM	1 AM	2 AM	3 AM	4 AM	6 AM	11 PM	Total
2020		1		205	1			207
2021				2020				2020
2022	1	1	2	390		4	5	403
Total	1	2	2	2615	1	4	5	2630

3 - Tool use by year (green = high / red = low)

	2020	2021	2022	Total
Brush/Weed Hook	179	545	964	1688
Grabber	161	702	659	1522
Light	97	161	125	383
Plug Wrench	211	653	724	1588
Total	648	2061	2472	5181
Minus Nighttime	441	41	2069	2551

4 - Tool use by day for station lifetime (green = high / red = low)

	Sun	Mon	Tue	Wed	Thu	Fri	Sat	Total
Brush/Weed Hook	85	98	465	35	69	317	619	1688
Grabber	112	88	113	78	89	320	722	1522
Light	38	12	51	22	26	59	175	383
Plug Wrench	167	173	72	134	108	231	703	1588
Total	402	371	701	269	292	927	2219	5181

5 - Key Insights

#	Metric	Value
1	Hour with Most Uses	3:00 AM
2	Day with Most Uses	Saturday
3	Day with 2 nd Most Uses	Friday
4	Year with Most Uses	2022
5	Year with Least Uses	2021

#	Metric	Value
6	Yearly Use Trend 21 to 22	UP
7	Tool with Most Uses	Brush
8	Tool with Least Uses	Light
9	Significant Outliers Detected	YES

*2018 not included

Significant Outliers Detected

Fish Lake Outpost (b)



Metrics Menu

6 - Average daily tool use per month

	2020				2021						2022							
	Jul	Aug	Sep	Oct	Mar	Apr	May	Oct	Nov	Dec	Mar	Apr	May	Jun	Jul	Aug	Sep	Oct
Brush/Weed Hook	0	3	2	1	0	1	4	13	0	0	0	0	14	0	12	4	2	0
Grabber	0	2	2	1	0	1	5	16	0	0	1	0	2	1	11	4	3	0
Light	1	2	0	0	0	0	1	4	0	0	0	0	0	2	1	1	1	0
Plug Wrench	0	4	2	1	0	1	5	15	0	0	0	0	2	3	8	3	2	4
Total	1	10	7	3	1	2	15	49	0	0	1	0	18	4	33	12	7	4
Days in Month	31	31	30	31	31	30	31	31	30	31	31	30	31	30	31	31	30	31

7 - July 4th tool use per year

No July 4th usage recorded

8 - Tool use by month per year (green = high / red = low)

	Mar	Apr	May	Jun	Jul	Aug	Sep	Oct	Nov	Dec	Total
2020					31	320	200	97			648
2021	22	58	467					1506	0	8	2061
2022	37	13	564	122	1031	364	212	129			2472
Total	59	71	1031	122	1062	684	412	1732	0	8	5181

9 - Tool use by month per year trends

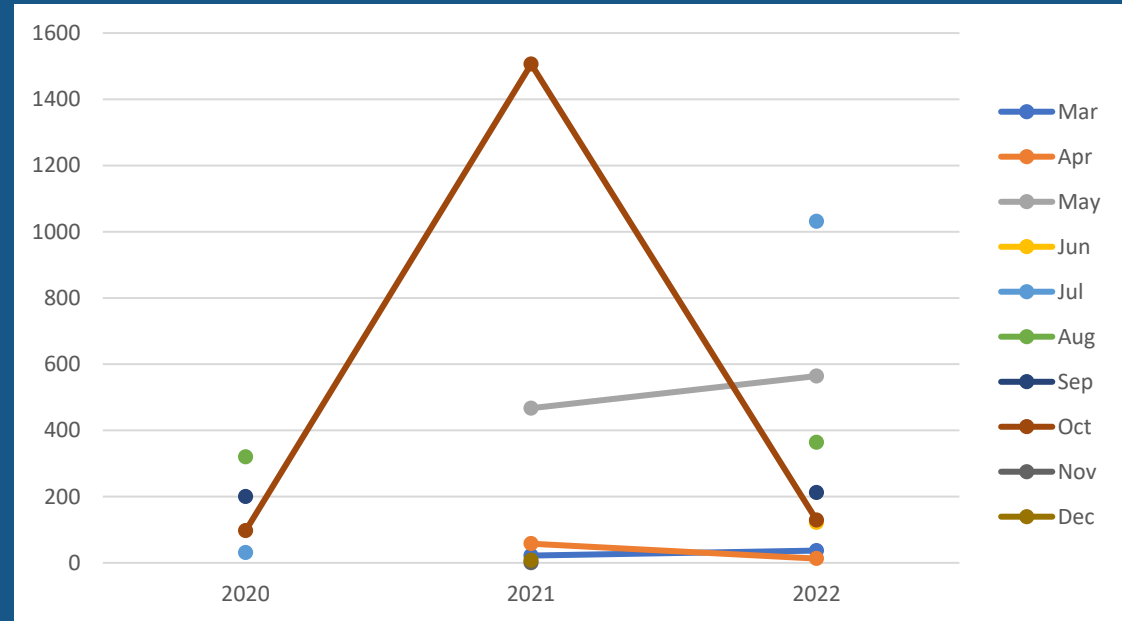

Sarah Outpost (a)



Metrics Menu

1 - Tool use by hour for station lifetime (green = high / red = low)

	12 AM	1 AM	2 AM	3 AM	4 AM	5 AM	6 AM	7 AM	8 AM	9 AM	10 AM	11 AM	12 PM	1 PM	2 PM	3 PM	4 PM	5 PM	6 PM	7 PM	8 PM	9 PM	10 PM	11 PM	Total
Brush/Weed Hook	3			6	2	2	2	1	45	35	77	252	57	117	55	97	90	75	72	60	66	25	8	0	1147
Grabber	8			9	0	5	0	5	32	39	111	319	82	61	94	94	82	103	93	71	96	33	7	2	1346
Light	6	1	1	1	1	2	1	4	1	11	12	18	21	17	16	12	15	27	15	18	24	34	11	2	271
Plug Wrench	5			3	0	5	2	6	21	59	75	106	99	86	95	84	92	105	115	101	112	39	13	1	1224
Total	22	1	1	19	3	14	5	16	99	144	275	695	259	281	260	287	279	310	295	250	298	131	39	5	3988

2- Yearly tool use for night time periods (green = low / red = high)

	12 AM	1 AM	2 AM	3 AM	4 AM	5 AM	6 AM	11 PM	Total
2019	17			2	1	14	3		37
2020	2			4	1		2		9
2021	3	1	1	13	1			1	20
2022				0				4	4
Total	22	1	1	19	3	14	5	5	70

3 - Tool use by year (green = high / red = low 2018 not included)

	2018	2019	2020	2021	2022	Total
Brush/Weed Hook	9	385	230	266	257	1147
Grabber	11	503	196	244	392	1346
Light	7	139	69	43	13	271
Plug Wrench	8	619	235	241	121	1224
Total	35	1646	730	794	783	3988
Minus Nighttime	35	1609	721	774	779	3918

4 - Tool use by day for station lifetime (green = high / red = low)

	Sun	Mon	Tue	Wed	Thu	Fri	Sat	Total
Brush/Weed Hook	194	113	305	92	121	134	188	1147
Grabber	249	140	340	95	134	138	250	1346
Light	53	34	35	23	25	45	56	271
Plug Wrench	251	174	186	99	122	132	260	1224
Total	747	461	866	309	402	449	754	3988

5 - Key Insights

#	Metric	Value
1	Hour with Most Uses	11:00 AM
2	Day with Most Uses	Tuesday
3	Day with 2 nd Most Uses	Saturday
4	Year with Most Uses	2020
5	Year with Least Uses	2021

#	Metric	Value
6	Yearly Use Trend 21 to 22	~FLAT
7	Tool with Most Uses	Grabber
8	Tool with Least Uses	Light
9	Significant Outliers Detected	YES

*2018 not included

Significant Outliers Detected

Sarah Outpost (b)



Metrics Menu

6 - Average daily tool use per month

	2018			2019											2020												2021											2022										
	Oct	Nov	Dec	Mar	Apr	May	Jun	Jul	Aug	Sep	Oct	Nov	Mar	Apr	May	Jun	Jul	Aug	Sep	Oct	Jan	Feb	Mar	Apr	May	Jun	Jul	Aug	Sep	Oct	Nov	May	Jul	Aug	Sep	Oct												
Brush/Weed Hook	0	0	0	0	0	3	3	3	2	1	0	0	0	0	1	3	1	1	1	0	0	0	0	0	1	2	1	1	1	2	1	0	0	0	0	0	1	2	1	1	2	1	0	1	6	1	0	0
Grabber	0	0	0	0	1	3	5	3	3	1	0	0	0	0	1	2	1	1	1	0	0	0	0	0	1	2	1	1	1	2	0	0	0	0	0	1	2	1	1	2	0	0	1	9	1	1	0	
Light	0	0	0	0	0	1	1	1	1	0	0	0	0	0	0	1	0	0	0	0	0	0	0	0	0	1	0	0	0	0	0	0	0	0	0	0	1	0	0	0	0	0	0	0	0	0	0	
Plug Wrench	0	0	0	0	1	4	5	4	3	2	1	0	0	0	1	3	1	2	1	0	0	0	0	0	1	2	1	2	1	0	0	0	0	0	1	2	1	0	0	0	0	0	2	1	1	0		
Total	1	1	0	0	2	11	14	11	9	5	2	0	0	0	3	8	4	5	3	1	0	0	0	1	4	7	4	4	5	2	0	2	17	4	2	0												
Days in Month	31	30	31	31	30	31	30	31	31	30	31	30	31	30	31	30	31	31	30	31	30	30	31	30	31	30	31	31	30	31	30	31	31	31	30	31												

7 - July 4th tool use per year

	2019	2020	2021	Total
Brush/Weed Hook	4	2	0	6
Grabber	7	1	1	9
Light	0	0	0	0
Plug Wrench	7	3	1	11
Total	18	6	2	26

8 - Tool use by month per year (green = high / red = low)

	Mar	Apr	May	Jun	Jul	Aug	Sep	Oct	Nov	Jan	Feb	Dec	Total
2018								17	15			3	35
2019	0	56	353	424	346	270	146	48	3				1646
2020	0	4	84	243	131	153	92	23		0	0		730
2021	10	15	122	199	119	129	140	54	6				794
2022			62		531	114	73	3					783
Total	10	75	621	866	1127	666	451	145	24	0	0	3	3988



9 - Tool use by month per year trends

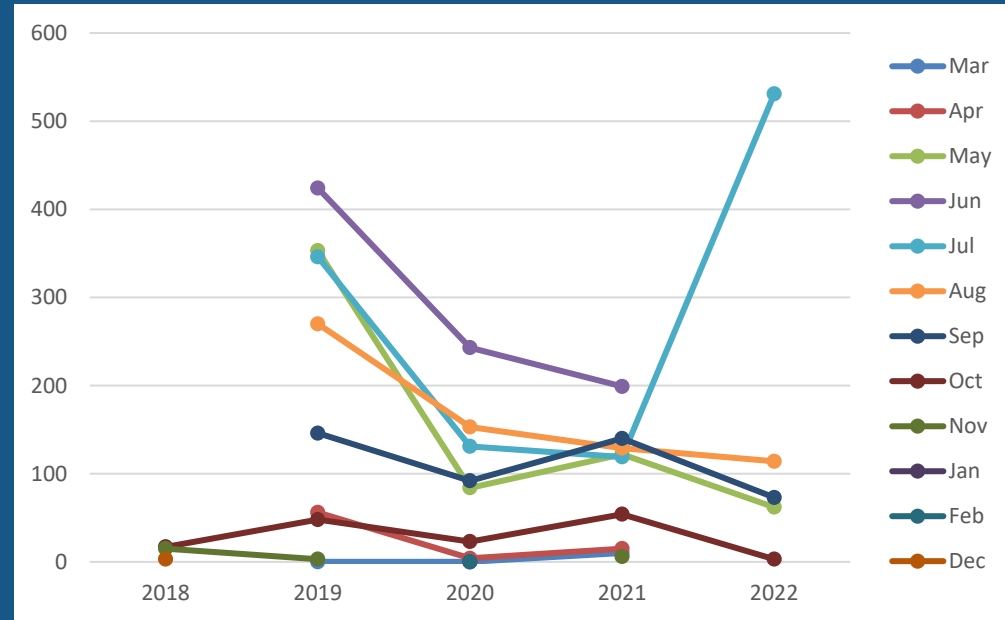

Weaver Outpost (a)



Metrics Menu

1 - Tool use by hour for station lifetime (green = high / red = low)

	12 AM	1 AM	2 AM	3 AM	4 AM	5 AM	6 AM	7 AM	8 AM	9 AM	10 AM	11 AM	12 PM	1 PM	2 PM	3 PM	4 PM	5 PM	6 PM	7 PM	8 PM	9 PM	10 PM	11 PM	Total
Brush/Weed Hook	14	6	7	86	1	4	2	19	16	27	30	16	33	55	106	69	68	90	85	99	60	30	7	3	933
Grabber				112		1	0	37	11	50	25	20	34	68	90	77	85	100	83	100	103	40	8	0	1044
Light	1			74		0	0	2	2	1	11	1	10	19	34	26	24	26	28	32	38	52	10	4	395
Plug Wrench				136		1	2	53	17	51	35	58	47	82	117	114	90	161	119	100	132	60	7	1	1383
Total	15	6	7	408	1	6	4	111	46	129	101	95	124	224	347	286	267	377	315	331	333	182	32	8	3755

2- Yearly tool use for night time periods (green = low / red = high)

	12 AM	1 AM	2 AM	3 AM	4 AM	5 AM	6 AM	11 PM	Total
2019	1			22		3	1	1	28
2020	14	6	7	234	1	3	2	6	273
2021				152			1	1	154
2022				0			0		0
Total	15	6	7	408	1	6	4	8	455



3 - Tool use by year (green = high / red = low)

	2019	2020	2021	2022	Total
Brush/Weed Hook	436	375	111	11	933
Grabber	394	384	236	30	1044
Light	139	185	69	2	395
Plug Wrench	544	488	305	46	1383
Total	1513	1432	721	89	3755
Minus Nighttime	1485	1159	567	89	3300



4 - Tool use by day for station lifetime (green = high / red = low)

	Sun	Mon	Tue	Wed	Thu	Fri	Sat	Total
Brush/Weed Hook	216	149	67	114	94	123	170	933
Grabber	197	136	113	107	130	147	214	1044
Light	73	49	39	46	53	73	62	395
Plug Wrench	275	159	136	148	163	212	290	1383
Total	761	493	355	415	440	555	736	3755

5 - Key Insights

#	Metric	Value
1	Hour with Most Uses	3:00 AM
2	Day with Most Uses	Sunday
3	Day with 2 nd Most Uses	Saturday
4	Year with Most Uses	2019
5	Year with Least Uses	2022

#	Metric	Value
6	Yearly Use Trend 21 to 22	DOWN
7	Tool with Most Uses	Wrench
8	Tool with Least Uses	Light
9	Significant Outliers Detected	YES

*2018 not included



Significant Outliers Detected

Weaver Outpost (b)



Metrics Menu

6 - Average daily tool use per month

	2019								2020								2021								2022		
	Apr	May	Jun	Jul	Aug	Sep	Oct		Apr	May	Jun	Jul	Aug	Sep	Oct		Mar	Apr	May	Jun	Jul	Aug	Sep		Apr	May	Jun
Brush/Weed Hook	0	4	3	4	2	1	0		9	1	0	1	1	0	0		0	0	1	1	1	0	0		0	0	0
Grabber	0	3	4	4	1	1	0		2	3	3	3	1	0	0		0	1	2	2	1	1	0		0	1	0
Light	0	1	2	0	1	1	0		1	1	1	1	1	0	0		0	0	1	1	0	0	0		0	0	0
Plug Wrench	0	3	6	5	3	1	0		2	3	3	3	2	1	0		1	1	2	3	3	1	0		0	1	0
Total	0	11	15	12	8	3	0		15	9	7	9	6	2	1		1	2	6	7	5	2	1		0	2	0
Days in Month	30	31	30	30	31	30	31		30	31	30	30	31	30	31		31	30	31	30	30	31	30		31	31	30



7 - July 4th tool use per year

	2019	2020	2021	Total
Brush/Weed Hook	9	0	2	11
Grabber	8	11	0	19
Light	0	4	2	6
Plug Wrench	9	16	4	29
Total	26	31	8	65

8 - Tool use by month per year (green = high / red = low)

	Mar	Apr	May	Jun	Jul	Aug	Sep	Oct	Total
2019		0	341	459	374	236	101	2	1513
2020		436	266	223	265	171	50	21	1432
2021	32	60	174	212	148	71	24		721
2022		6	69	14					89
Total	32	502	850	908	787	478	175	23	3755

9 - Tool use by month per year trends

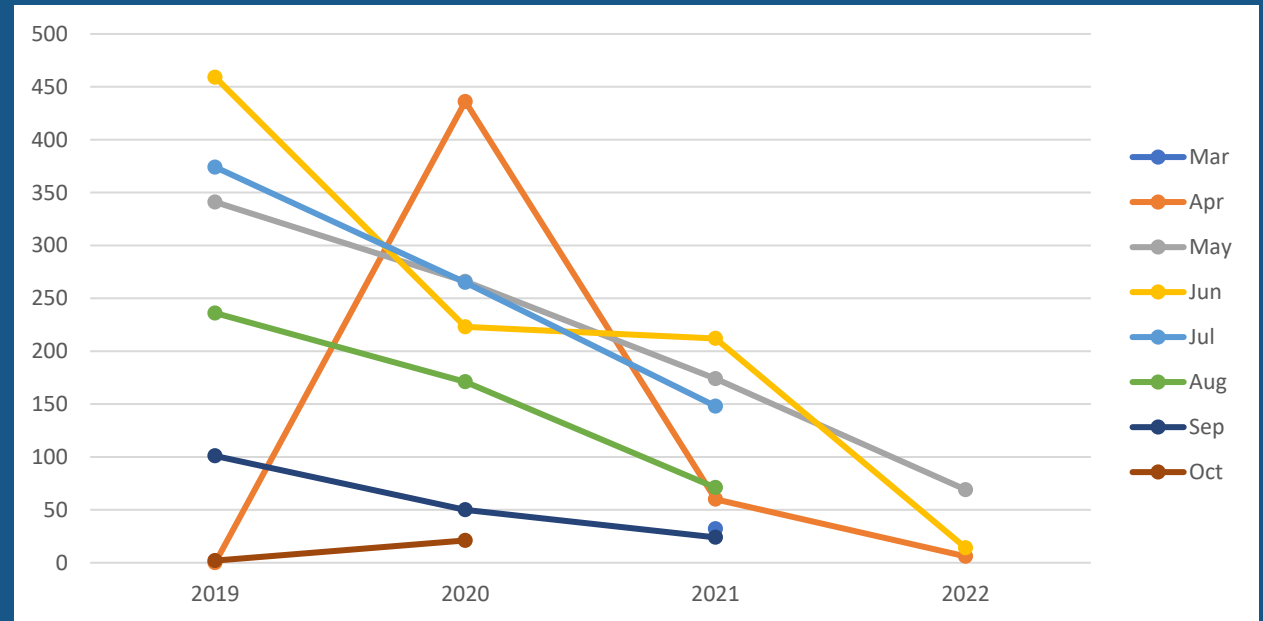

Parkers Outpost (a)



Metrics Menu

1 - Tool use by hour for station lifetime (green = high / red = low)

	12 AM	1 AM	2 AM	3 AM	4 AM	5 AM	6 AM	7 AM	8 AM	9 AM	10 AM	11 AM	12 PM	1 PM	2 PM	3 PM	4 PM	5 PM	6 PM	7 PM	8 PM	9 PM	10 PM	11 PM	Total
Brush/Weed Hook	1	0	0	6	4	2	6	4	10	16	45	52	49	48	44	47	46	46	38	54	52	36	3	0	609
Grabber	9	7	23	41	11	3	14	13	43	31	150	154	134	222	92	173	133	76	82	78	114	79	18	1	1701
Light	0			2		0	1	1	4	10	14	17	20	-51	79	23	12	15	18	20	30	30	5		250
Plug Wrench	0	1		13		0	8	7	15	20	50	58	61	103	61	71	60	38	91	73	92	68	2		892
Total	10	8	23	62	15	5	29	25	72	77	259	281	264	322	276	314	251	175	229	225	288	213	28	1	3452



2- Yearly tool use for night time periods (green = low / red = high)

	12 AM	1 AM	2 AM	3 AM	4 AM	5 AM	6 AM	11 PM	Total
2018					2	2			4
2019	3	8	21	57	9	3	26	0	127
2020	1			2	4		1		8
2021				0			2		2
2022	6		2	3				1	12
Total	10	8	23	62	15	5	29	1	153



3 - Tool use by year (green = high / red = low 2018 not included)

s	2018	2019	2020	2021	2022	Total
Brush/Weed Hook	10	245	98	165	91	609
Grabber	27	492	237	400	545	1701
Light	0	72	59	75	44	250
Plug Wrench	10	368	159	195	160	892
Total	47	1177	553	835	840	3452
Minus Nighttime	43	1050	545	833	828	3299

4 - Tool use by day for station lifetime (green = high / red = low)

	Sun	Mon	Tue	Wed	Thu	Fri	Sat	Total
Brush/Weed Hook	172	68	58	64	69	79	99	609
Grabber	501	200	179	194	258	61	308	1701
Light	-13	25	33	36	27	100	42	250
Plug Wrench	260	102	100	90	105	70	165	892
Total	920	395	370	384	459	310	614	3452



5 - Key Insights

#	Metric	Value
1	Hour with Most Uses	3:00 AM
2	Day with Most Uses	Sunday
3	Day with 2 nd Most Uses	Saturday
4	Year with Most Uses	2019
5	Year with Least Uses	2022

#	Metric	Value
6	Yearly Use Trend 21 to 22	DOWN
7	Tool with Most Uses	Grabber
8	Tool with Least Uses	Light
9	Significant Outliers Detected	YES

*2018 not included



Significant Outliers Detected

Parkers Outpost (b)



Metrics Menu

6 - Average daily tool use per month

	Oct	Apr	May	Jun	Jul	Aug	Sep	Oct	Jun	Jul	Aug	Sep	Oct	Mar	Apr	May	Jun	Jul	Aug	Sep	Oct	Mar	Apr	May	Jun	Jul	Aug	Sep	
Brush/Weed Hook	0	0	2	2	2	1	1	0	1	1	1	1	0	0	0	1	1	1	1	0	0	0	0	1	1	0	0	0	
Grabber	1	0	4	5	2	2	2	1	1	3	2	1	0	0	0	1	6	2	3	1	0	0	0	0	5	5	2	1	5
Light	0	0	0	1	1	0	0	0	0	1	1	0	0	0	0	0	1	0	0	0	0	0	0	0	1	0	0	0	
Plug Wrench	0	0	3	4	2	2	1	0	1	2	1	1	0	0	1	2	1	1	1	0	0	0	0	1	2	1	1	0	
Total	1	0	10	11	7	5	4	1	2	7	5	3	1	0	2	5	9	4	5	2	0	0	0	7	9	4	2	5	
Days in Month	31	30	31	30	31	31	30	31	30	31	31	30	31	31	30	31	30	31	31	31	31	31	30	31	30	31	31	31	



7 - July 4th tool use per year

	2019	2020	2021	2022	Total
Brush/Weed Hook	1	2	0	0	3
Grabber	1	2	2	0	5
Light	0	1	1	1	3
Plug Wrench	2	3	0	0	5
Total	4	8	3	1	16

8 - Tool use by month per year (green = high / red = low)

	Mar	Apr	May	Jun	Jul	Aug	Sep	Oct	Nov	Dec	Jan	Feb	Total
2018								39	8	0			47
2019		3	311	337	217	143	126	40			0	0	1177
2020				72	228	156	80	17					553
2021	7	50	152	276	131	156	49	14	0	0			835
2022	2	14	202	284	128	47	163						840
Total	9	67	665	969	704	502	418	110	8	0	0	0	3452

9 - Tool use by month per year trends

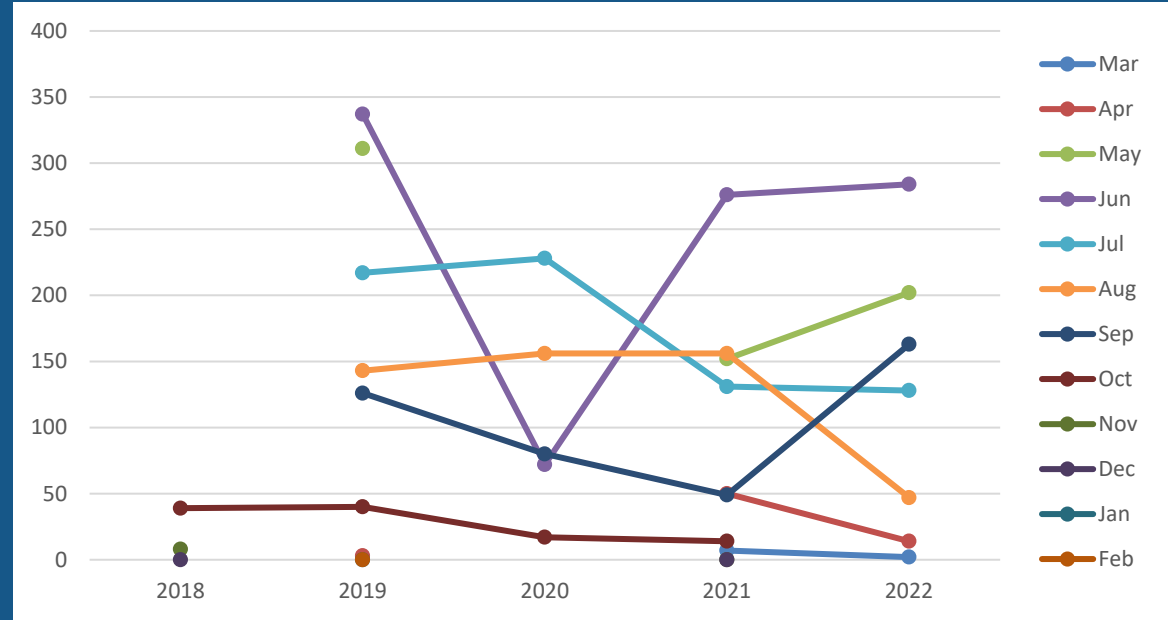

Mitchel Outpost (a)



Metrics Menu

1 - Tool use by hour for station lifetime (green = high / red = low)

	12 AM	1 AM	2 AM	3 AM	4 AM	5 AM	6 AM	7 AM	8 AM	9 AM	10 AM	11 AM	12 PM	1 PM	2 PM	3 PM	4 PM	5 PM	6 PM	7 PM	8 PM	9 PM	10 PM	11 PM	Total
Brush/Weed Hook	7	12	14	108	6	5	3	1	11	12	9	9	27	23	26	40	21	27	23	36	26	18	4	5	473
Grabber	1	4	4	135		3	5	7	3	12	17	25	17	29	31	20	19	21	7	25	21	10			416
Light	1		1	32			1	1	4	8	9	13	10	14	14	12	21	24	26	24	30	34	15	2	296
Plug Wrench		1	2	149	2		4	7	18	25	35	50	53	51	58	74	73	87	66	126	81	45	6	9	1022
Total	9	17	21	424	8	8	13	16	36	57	70	97	107	117	129	146	134	159	122	211	158	107	25	16	2207

2- Yearly tool use for night time periods (green = low / red = high)

	12 AM	1 AM	2 AM	3 AM	4 AM	5 AM	6 AM	11 PM	Total
2021	1	6	16	379	8	3	4	7	424
2022	8	11	5	45		5	9	9	92
Total	9	17	21	424	8	8	13	16	516



3 - Tool use by year (green = high / red = low)

	2021	2022	Total
Brush/Weed Hook	274	199	473
Grabber	206	210	416
Light	171	125	296
Plug Wrench	547	475	1022
Total	1198	1009	2207
Minus Nighttime	774	493	1691

4 - Tool use by day for station lifetime (green = high / red = low)

	Sun	Mon	Tue	Wed	Thu	Fri	Sat	Total
Brush/Weed Hook	72	61	39	37	48	68	148	473
Grabber	65	54	96	64	36	36	65	416
Light	54	51	44	24	28	28	67	296
Plug Wrench	188	151	118	128	107	143	187	1022
Total	379	317	297	253	219	275	467	2207

5 - Key Insights

#	Metric	Value
1	Hour with Most Uses	3:00 AM
2	Day with Most Uses	Saturday
3	Day with 2 nd Most Uses	Sunday
4	Year with Most Uses	2021
5	Year with Least Uses	2022

#	Metric	Value
6	Yearly Use Trend 21 to 22	DOWN
7	Tool with Most Uses	Wrench
8	Tool with Least Uses	Light
9	Significant Outliers Detected	YES

*2018 not included

Significant Outliers Detected

Mitchel Outpost (b)



Metrics Menu

6 - Average daily tool use per month

	2021											2022							
	Apr	May	Jun	Jul	Aug	Sep	Oct	Nov	Dec	Mar		Apr	May	Jun	Jul	Aug	Sep	Oct	
Brush/Weed Hook	0	2	3	1	1	1	0	0	0	0	0	0	3	2	1	0	0	0	
Grabber	0	1	1	1	2	1	0	0	0	1	0	1	2	2	1	0	0	0	
Light	0	1	1	1	1	1	0	0	0	0	0	1	1	1	1	0	0	0	
Plug Wrench	0	4	5	3	3	2	0	0	0	0	0	3	4	4	3	1	0	0	
Total	0	9	11	7	7	5	1	0	0	1	1	8	9	7	5	2	0	0	
Days in Month	30	31	30	31	31	30	31	30	31	30	31	31	30	31	31	30	31	31	

7 - July 4th tool use per year

	2021	2022	Total
Brush/Weed Hook	1	2	3
Grabber	2	0	2
Light	3	0	3
Plug Wrench	4	13	17
Total	10	15	25

8 - Tool use by month per year (green = high / red = low)

	Mar	Apr	May	Jun	Jul	Aug	Sep	Oct	Nov	Dec	Total
2021		1	274	323	209	213	140	19	13	6	1198
2022	32	27	252	260	217	153	66	2			1009
Total	32	28	526	583	426	366	206	21	13	6	2207

9 - Tool use by month per year trends

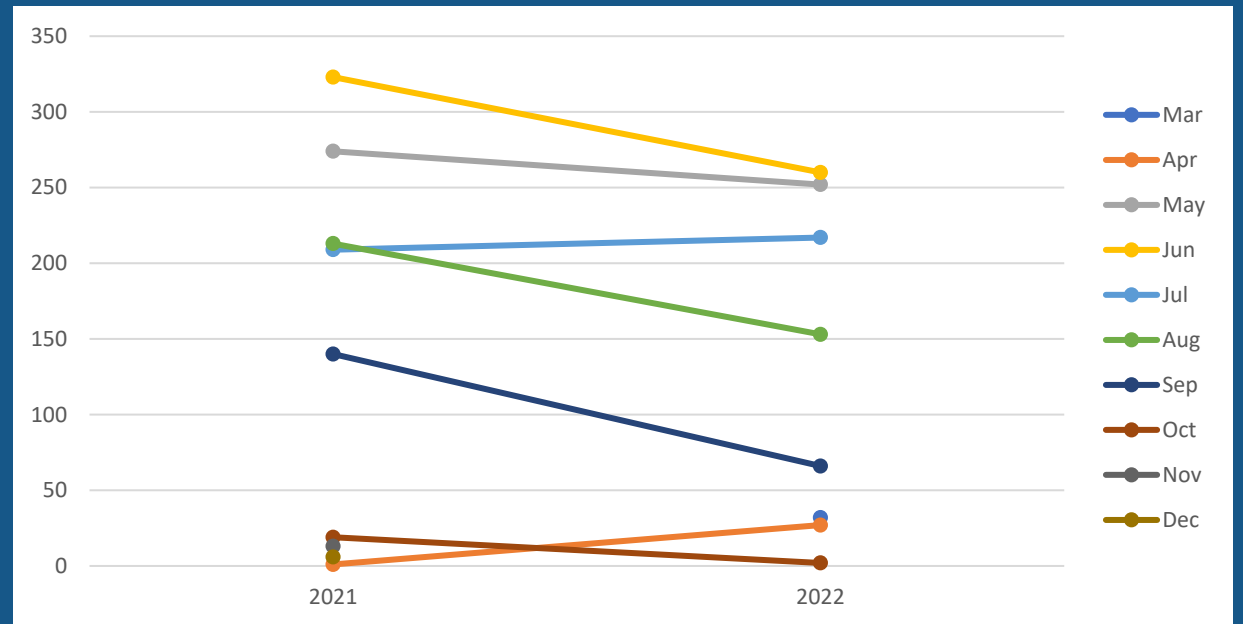

Twin Lake (a)



Metrics Menu

1 - Tool use by hour for station lifetime (green = high / red = low)

	12 AM	1 AM	2 AM	3 AM	4 AM	5 AM	6 AM	7 AM	8 AM	9 AM	10 AM	11 AM	12 PM	1 PM	2 PM	3 PM	4 PM	5 PM	6 PM	7 PM	8 PM	9 PM	10 PM	11 PM	Total
Brush/Weed Hook	7	12	14	92	6	4	2	1	11	8	6	8	22	20	23	40	20	26	20	35	25	16	4	5	427
Grabber	1	3	2	23		3	4			1	4	6	7	7	1	6	5	8	3	8	9	3			104
Light	1		1	13				1	2	6	3	8	7	10	4	6	15	12	23	20	27	26	15	2	202
Plug Wrench		1		69	2		1	5	10	12	11	22	27	28	36	54	48	52	56	67	65	33	6	9	614
Total	9	16	17	197	8	7	7	7	23	27	24	44	63	65	64	106	88	98	102	130	126	78	25	16	1347

2 - Yearly tool use for night time periods (green = low / red = high)

	12 AM	1 AM	2 AM	3 AM	4 AM	5 AM	6 AM	11 PM	Total
2021	1	6	12	189	8	3	2	7	228
2022	8	10	5	8		4	5	9	49
Total	9	16	17	197	8	7	7	16	277



3 - Tool use by year (green = high / red = low)

	2021	2022	Total
Brush/Weed Hook	243	184	427
Grabber	47	57	104
Light	120	82	202
Plug Wrench	348	266	614
Total	758	589	1347
Minus Nighttime	530	312	1070

4 - Tool use by day for station lifetime (green = high / red = low)

	Sun	Mon	Tue	Wed	Thu	Fri	Sat	Total
Brush/Weed Hook	68	58	33	21	42	63	142	427
Grabber	29	15	28	11	4	7	10	104
Light	40	33	27	16	19	19	48	202
Plug Wrench	114	97	77	51	62	86	127	614
Total	251	203	165	99	127	175	327	1347

5 - Key Insights

#	Metric	Value
1	Hour with Most Uses	3:00 AM
2	Day with Most Uses	Saturday
3	Day with 2 nd Most Uses	Sunday
4	Year with Most Uses	2021
5	Year with Least Uses	2022

#	Metric	Value
6	Yearly Use Trend 21 to 22	DOWN
7	Tool with Most Uses	Wrench
8	Tool with Least Uses	Grabber
9	Significant Outliers Detected	YES

*2018 not included

Significant Outliers Detected

Twin Lake (b)



Metrics Menu

6 - Average daily tool use per month

	2021										2022							
	Apr	May	Jun	Jul	Aug	Sep	Oct	Nov	Dec	Mar	Apr	May	Jun	Jul	Aug	Sep	Oct	
Brush/Weed Hook	0	2	2	1	1	1	0	0	0	0	0	3	1	1	0	0	0	
Grabber	0	0	0	0	0	0	0	0	0	0	0	0	1	1	0	0	0	
Light	0	1	1	1	1	1	0	0	0	0	0	0	1	1	1	0	0	
Plug Wrench	0	3	3	2	2	1	0	0	0	0	0	2	3	2	2	1	0	
Total	0	7	6	4	4	3	0	0	0	0	1	5	6	4	3	1	0	
Days in Month	30	31	30	31	31	30	31	30	30	31	30	31	30	31	31	30	31	

7 - July 4th tool use per year

	2021	2022	Total
Brush/Weed Hook	1	2	3
Grabber	2	0	2
Light	2	0	2
Plug Wrench	3	11	14
Total	8	13	21

8 - Tool use by month per year (green = high / red = low)

	Mar	Apr	May	Jun	Jul	Aug	Sep	Oct	Nov	Dec	Total
2021		1	202	194	136	124	86	12	1	2	758
2022	0	22	148	179	121	85	34	0			589
Total	0	23	350	373	257	209	120	12	1	2	1347

9 - Tool use by month per year trends

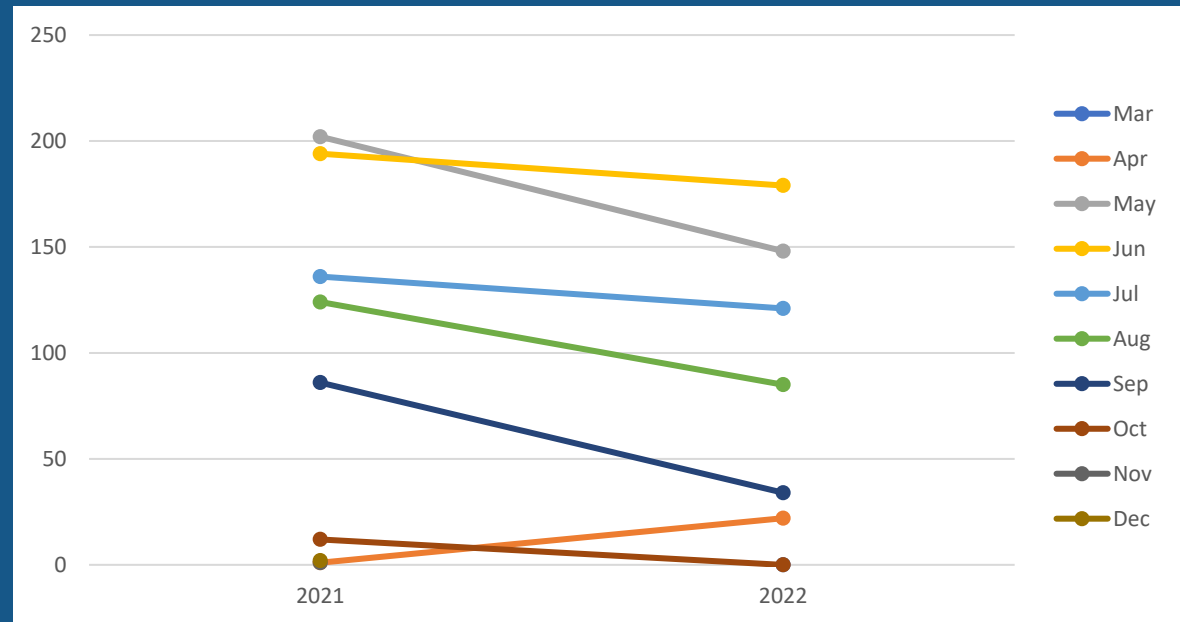

Carsons Bay / Mtka (a)



Metrics Menu

1 - Tool use by hour for station lifetime (green = high / red = low)

	12 AM	2 AM	3 AM	4 AM	5 AM	6 AM	7 AM	8 AM	9 AM	10 AM	11 AM	12 PM	1 PM	2 PM	3 PM	4 PM	5 PM	6 PM	7 PM	8 PM	9 PM	10 PM	11 PM	Total
Brush/Weed Hook			16			1		4	11	12	6	3	46	10	14	12	15	9	13	4	1	1		178
Grabber	6	1	46	2			4	11	8	18	23	23	31	33	25	34	13	23	30	14	12	1	2	360
Light	1		33		3	5			2	3	7	2	10	4	7	4	4	6	13	8	16	11		139
Plug Wrench			49			1	1	6	4	22	12	12	17	26	31	29	31	44	30	13	9	2		339
Total	7	1	144	2	3	7	5	21	25	55	48	40	104	73	77	79	63	82	86	39	38	15	2	1016

2- Yearly tool use for night time periods (green = low / red = high)

	12 AM	2 AM	3 AM	4 AM	5 AM	6 AM	11 PM	Total
2021		1	100	2	3	4	1	111
2022	7		44			3	1	55
Total	7	1	144	2	3	7	2	166



3 - Tool use by year (Aug 2021 start - no color coding)

	2021	2022	Total
Brush/Weed Hook	71	107	178
Grabber	122	238	360
Light	66	73	139
Plug Wrench	119	220	339
Total	378	638	1016
Minus Nighttime	267	472	850

4 - Tool use by day for station lifetime (green = high / red = low)

	Sun	Mon	Tue	Wed	Thu	Fri	Sat	Total
Brush/Weed Hook	24	65	17	18	12	14	28	178
Grabber	42	40	39	34	139	40	26	360
Light	29	18	22	22	19	19	10	139
Plug Wrench	62	35	46	42	58	41	55	339
Total	157	158	124	116	228	114	119	1016

5 - Key Insights

#	Metric	Value
1	Hour with Most Uses	3:00 AM
2	Day with Most Uses	Thursday
3	Day with 2 nd Most Uses	Monday
4	Year with Most Uses	NA
5	Year with Least Uses	NA

#	Metric	Value
6	Yearly Use Trend 21 to 22	NA
7	Tool with Most Uses	Grabber
8	Tool with Least Uses	Light
9	Significant Outliers Detected	YES

*2018 not included

Significant Outliers Detected

Carsons Bay / Mtka (b)



Metrics Menu

6 - Average daily tool use per month

	2021						2022							
	Aug	Sep	Oct	Nov	Dec		Mar	Apr	Jun	Jul	Aug	Sep	Oct	Jan
Brush/Weed Hook	1	0	1	0	0	0	0	1	1	0	1	0	0	0
Grabber	1	2	1	0	0	0	0	1	2	1	3	1	0	0
Light	1	1	0	0	0	0	0	1	1	0	1	0	0	0
Plug Wrench	2	2	1	0	0	0	0	2	2	1	1	1	0	0
Total	4	5	3	0	0	0	1	4	5	3	6	2	0	0
Days in Month	31	30	31	30	31	31	31	30	31	31	30	31	31	30



7 - July 4th tool use per year

	2022	Total
Brush/Weed Hook	0	0
Grabber	0	0
Light	0	0
Plug Wrench	0	0
Total	0	0

8 - Tool use by month per year (green = high / red = low)

	Mar	Apr	Jun	Jul	Aug	Sep	Oct	Nov	Dec	Jan	Feb	Total
2021					139	138	101	0	0			378
2022	3	22	125	147	90	175	75			0	1	638
Total	3	22	125	147	229	313	176	0	0	0	1	1016

9 - Tool use by month per year trends

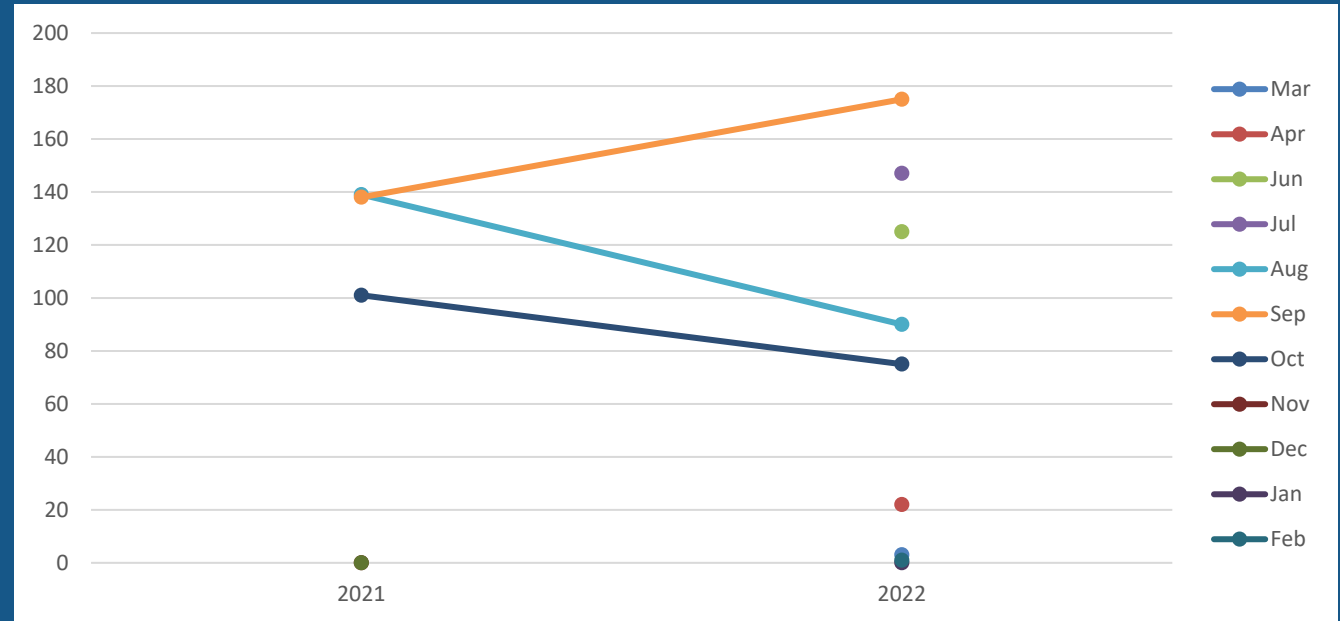

Eagle Outpost (a)



Metrics Menu

1 - Tool use by hour for station lifetime (green = high / red = low)

	12 AM	1 AM	2 AM	3 AM	4 AM	5 AM	7 AM	8 AM	10 AM	11 AM	12 PM	1 PM	2 PM	3 PM	4 PM	5 PM	6 PM	7 PM	8 PM	9 PM	10 PM	11 PM	Total
Brush/Weed Hook	8	11	5	2	1			0	1		0	8	4	2	23	15	13	14	7	6	8	13	141
Grabber	34	29	11	3	0	1	1	1	1	1	1	9	14	13	28	31	28	29	29	16	17	19	316
Light	23	19	37	7	0	2		1	1	1	3	1	2	3	2	6	7	1	10	1	7	7	141
Plug Wrench	40	36	26	3	0	1	1	0	2	1	5	19	21	12	29	28	42	32	42	25	37	33	435
Total	105	95	79	15	1	4	2	2	5	3	9	37	41	30	82	80	90	76	88	48	69	72	1033

2 - Yearly tool use for night time periods (green = low / red = high)

	12 AM	1 AM	2 AM	3 AM	4 AM	5 AM	11 PM	Total
2021	85	77	73	13	0	4	54	306
2022	20	18	6	2	1		18	65
Total	105	95	79	15	1	4	72	371

3 - Tool use by year (green = high / red = low)

	2021	2022	Total
Brush/Weed Hook	91	50	141
Grabber	205	111	316
Light	139	2	141
Plug Wrench	278	157	435
Total	713	320	1033
Minus Nighttime	407	255	662

4 - Tool use by day for station lifetime (green = high / red = low)

	Sun	Mon	Tue	Wed	Thu	Fri	Sat	Total
Brush/Weed Hook	18	22	15	23	16	17	30	141
Grabber	54	45	50	38	38	37	54	316
Light	22	18	25	20	23	8	25	141
Plug Wrench	76	68	56	48	58	53	76	435
Total	170	153	146	129	135	115	185	1033

5 - Key Insights

#	Metric	Value
1	Hour with Most Uses	12:00 AM
2	Day with Most Uses	Saturday
3	Day with 2 nd Most Uses	Sunday
4	Year with Most Uses	2021
5	Year with Least Uses	2022

#	Metric	Value
6	Yearly Use Trend 21 to 22	DOWN
7	Tool with Most Uses	Wrench
8	Tool with Least Uses	Light/Brush
9	Significant Outliers Detected	YES

*2018 not included

Significant Outliers Detected

Eagle Outpost (b)



Metrics Menu

6 - Average daily tool use per month

	2021								2022							
	May	Jun	Jul	Aug	Sep	Oct	Nov	Dec	Mar	Apr	May	Jun	Jul	Aug	Sep	Oct
Brush/Weed Hook	0	1	1	0	1	0	0	0	0	0	0	0	1	0	0	0
Grabber	2	1	2	1	1	0	0	0	0	0	0	1	1	1	0	0
Light	1	1	1	1	1	0	0	0	0	0	0	0	0	0	0	0
Plug Wrench	2	2	2	2	1	0	0	0	0	0	1	1	2	1	1	0
Total	5	4	6	4	4	1	0	0	0	0	1	2	4	2	1	0
Days in Month	31	30	31	31	30	31	30	31	31	30	31	30	31	31	30	31

7 - July 4th tool use per year

	2021	2022	Total
Brush/Weed Hook	0	2	2
Grabber	1	0	1
Light	2		2
Plug Wrench	2	3	5
Total	5	5	10

8 - Tool use by month per year (green = high / red = low)

	Mar	Apr	May	Jun	Jul	Aug	Sep	Oct	Nov	Dec	Total
2021			157	129	173	121	113	20	0	0	713
2022	4	14	45	53	112	65	24	3			320
Total	4	14	202	182	285	186	137	23	0	0	1033

9 - Tool use by month per year trends

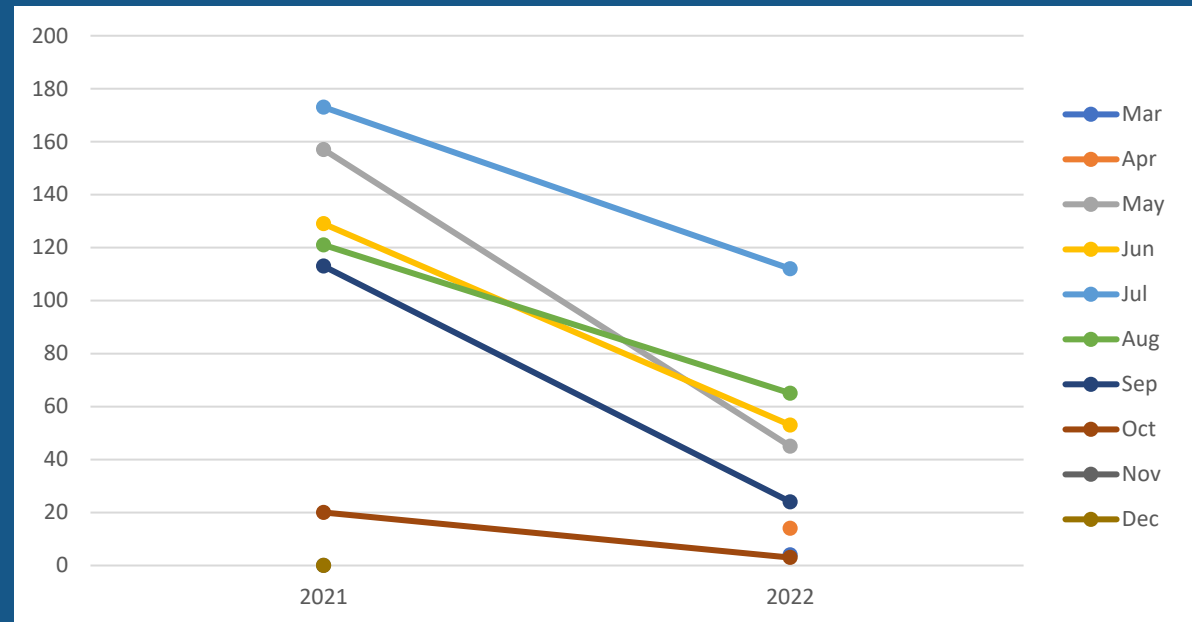

Little Long Lake Outpost (a)



Metrics Menu

1 - Tool use by hour for station lifetime (green = high / red = low)

	12 AM	1 AM	2 AM	3 AM	5 AM	6 AM	7 AM	8 AM	9 AM	10 AM	11 AM	12 PM	1 PM	2 PM	3 PM	4 PM	5 PM	6 PM	7 PM	8 PM	9 PM	10 PM	11 PM	Total
Brush/Weed Hook	3	2	1	35	0		0	3	3	19	6	7	9	11	15	17	12	9	10	10	12	1	0	185
Grabber	5	1	1	13	0	3	1	6	6	21	12	17	21	14	16	12	16	7	14	24	8	4	1	223
Light				5	0	1	1		1	8	-2	3	3	7	13	3	3	4	10	6	3	1	0	70
Plug Wrench	1	1	2	41	0		1	8	9	18	12	16	28	19	12	21	15	14	27	16	26		0	287
Total	9	4	4	94	0	4	3	17	19	66	28	43	61	51	56	53	46	34	61	56	49	6	1	765

2- Yearly tool use for night time periods (green = low / red = high)

	12 AM	1 AM	2 AM	3 AM	5 AM	6 AM	11 PM	Total
2020	7	1		72			1	81
2021	2	3	4	22	0	4	0	35
Total	9	4	4	94	0	4	1	116



3 - Tool use by year (green = high / red = low)

	2020	2021	Total
Brush/Weed Hook	85	100	185
Grabber	79	144	223
Light	35	35	70
Plug Wrench	100	187	287
Total	299	466	765
Minus Nighttime	218	431	649



4 - Tool use by day for station lifetime (green = high / red = low)

	Sun	Mon	Tue	Wed	Thu	Fri	Sat	Total
Brush/Weed Hook	24	13	15	39	37	31	26	185
Grabber	43	27	52	18	23	19	41	223
Light	10	8	8	11	12	7	14	70
Plug Wrench	48	18	70	50	20	22	59	287
Total	125	66	145	118	92	79	140	765

5 - Key Insights

#	Metric	Value
1	Hour with Most Uses	3:00 AM
2	Day with Most Uses	Tuesday
3	Day with 2 nd Most Uses	Saturday
4	Year with Most Uses	2021
5	Year with Least Uses	2022

#	Metric	Value
6	Yearly Use Trend 21 to 22	DOWN
7	Tool with Most Uses	Wrench
8	Tool with Least Uses	Light
9	Significant Outliers Detected	YES

*2018 not included

Significant Outliers Detected

Little Long Lake Outpost (b)



Metrics Menu

6 - Average daily tool use per month

	2020					2021									
	Jul	Aug	Sep	Oct	Feb	Mar	Apr	May	Jun	Jul	Aug	Sep	Oct	Nov	Dec
Brush/Weed Hook	2	1	0	0	0	0	0	0	1	0	0	1	0	0	0
Grabber	1	1	0	0	0	1	0	0	1	1	1	0	0	0	0
Light	0	0	0	0	0	0	0	0	0	0	0	0	0	0	0
Plug Wrench	2	1	0	0	0	1	1	1	2	1	1	0	0	0	0
Total	5	3	1	0	1	3	1	2	4	2	2	1	0	0	0
Days in Month	31	31	30	31	30	31	30	31	30	31	31	30	31	30	31

7 - July 4th tool use per year

	2021	Total
Plug Wrench	1	1
Total	1	1

8 - Tool use by month per year (green = high / red = low)

	Mar	Apr	May	Jun	Jul	Aug	Sep	Oct	Nov	Dec	Feb	Total
2020					143	95	35	5			21	299
2021	82	33	60	126	50	69	41	5	0	0		466
Total	82	33	60	126	193	164	76	10	0	0	21	765

9 - Tool use by month per year trends

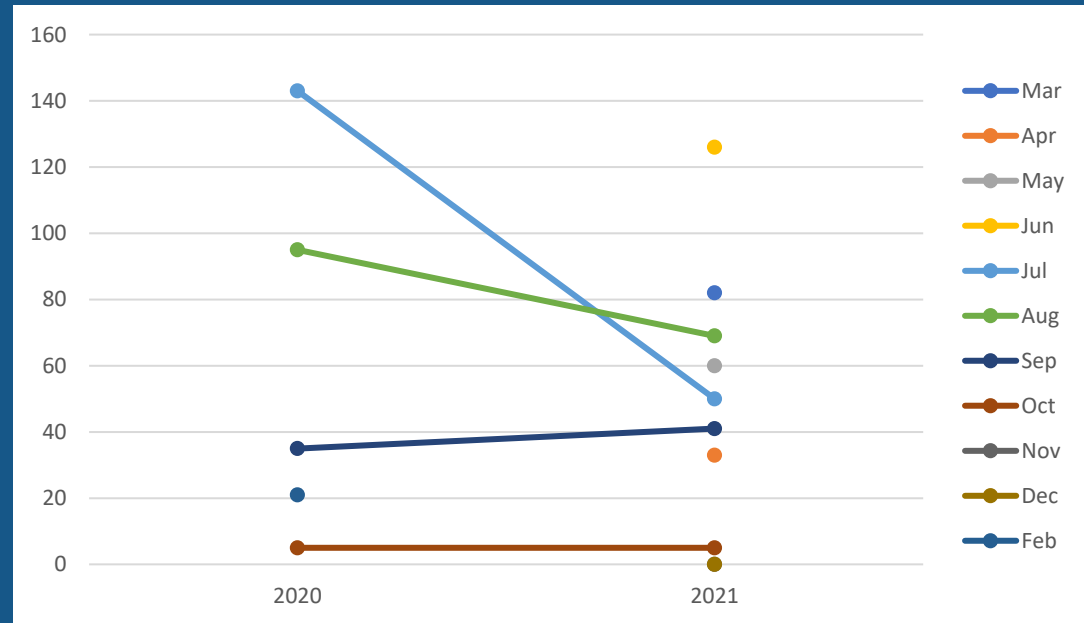

LMCD Outpost (a)



Metrics Menu

1 - Tool use by hour for station lifetime (green = high / red = low)

	12 AM	1 AM	2 AM	3 AM	4 AM	5 AM	6 AM	7 AM	8 AM	9 AM	10 AM	11 AM	12 PM	1 PM	2 PM	3 PM	4 PM	5 PM	6 PM	7 PM	8 PM	9 PM	10 PM	11 PM	Total
Brush Uses			1	0	1				4	1	1	6	7	5	8	9	12	19	15	21	19	13	1		143
Light Uses				0					1	1	1	3	3	0	2	5	7	6	4	6	13	27	9	2	90
Plug Wrench Uses				0			1	1	2	4	5	17	18	14	18	28	35	38	29	41	45	24	9		329
Reach Grabber Uses	2	1	12	1	4	5		7	3	13	17	32	24	25	36	54	49	71	50	61	73	55	10		605
Total	2	1	13	1	5	5	1	8	10	19	24	58	52	44	64	96	103	134	98	129	150	119	29	2	1167

2 - Yearly tool use for night time periods (green = low / red = high)

	12 AM	1 AM	2 AM	3 AM	4 AM	5 AM	6 AM	11 PM	Total
2022	2	1	13	1	5	5	1	2	30
Total	2	1	13	1	5	5	1	2	30

3 - Tool use by year (green = high / red = low)

	2022	Total
Brush Uses	143	143
Light Uses	90	90
Plug Wrench Uses	329	329
Reach Grabber Uses	605	605
Total	1167	1167
Minus Nighttime	1137	1137

4 - Tool use by day for station lifetime (green = high / red = low)

	Sun	Mon	Tue	Wed	Thu	Fri	Sat	Total
Brush Uses	30	22	16	21	18	12	24	143
Light Uses	21	11	11	11	5	17	14	90
Plug Wrench Uses	73	56	19	43	33	42	63	329
Reach Grabber Uses	100	105	47	62	64	96	131	605
Total	224	194	93	137	120	167	232	1167

5 - Key Insights

#	Metric	Value
1	Hour with Most Uses	8:00 PM
2	Day with Most Uses	Saturday
3	Day with 2 nd Most Uses	Sunday
4	Year with Most Uses	NA
5	Year with Least Uses	NA

#	Metric	Value
6	Yearly Use Trend 21 to 22	NA
7	Tool with Most Uses	Grabber
8	Tool with Least Uses	Light
9	Significant Outliers Detected	NO

*2018 not included

LMCD Outpost (b)



Metrics Menu

6 - Average daily tool use per month

	2022						
	Apr	May	Jun	Jul	Aug	Sep	Oct
Brush Uses	0	0	1	1	1	1	0
Light Uses	0	0	1	1	1	1	0
Plug Wrench Uses	0	1	3	3	2	1	0
Reach Grabber Uses	3	3	4	3	4	2	0
Total	4	5	9	8	8	4	1
Days in Month	30	31	30	31	31	30	31

7 - July 4th tool use per year

	2022	Total
Brush Uses	0	0
Light Uses	0	0
Plug Wrench Uses	4	4
Reach Grabber Uses	5	5
Total	9	9

8 - Tool use by month per year (green = high / red = low)

	Apr	May	Jun	Jul	Aug	Sep	Oct	Total
2022	108	157	267	245	243	123	24	1167
Total	108	157	267	245	243	123	24	1167

9 - Tool use by month per year trends

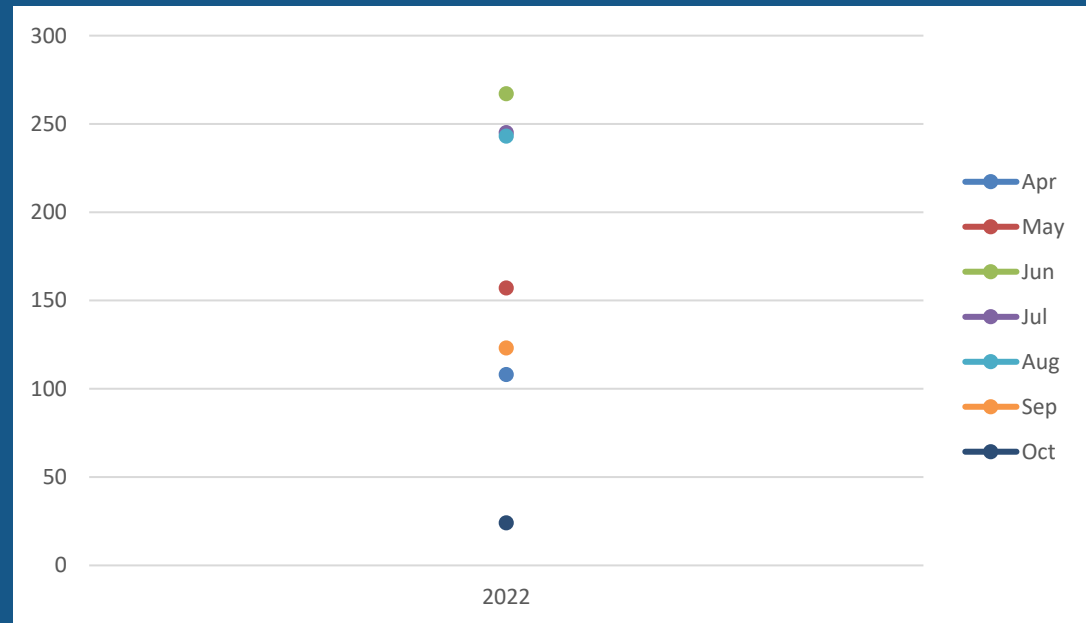

Key Project Findings

CD3 Data Science Project Key Findings

Significant outliers have been detected at nearly all Hennepin County CD3 locations

- 91% of Hennepin County CD3 locations have significant outliers detected
- Outlier analysis has revealed severe weather can lead to significant outliers
- 55% of Hennepin County CD3 locations most used hour is 3 AM

CD3 use is declining at nearly all Hennepin County CD3 locations

- 2022 was Year of Least Use for 59% of locations
- 68% of Locations had a Downward Trend from 2021 to 2022

CD3 Data Science Project Recommendations

- Invest in data analysis and stabilization to better understand CD3 use at existing stations before buying more stations
- Conduct a documented detailed inspection and remediation of Hennepin County CD3 data
- Develop and implement CD3 data governance model and practices to ensure the on-going integrity of the CD3 data
- Expand CD3 metric use beyond “cumulative use” based views
- Use expanded CD3 metrics to promote use at CD3 locations
- Consider adding scoreboards at locations to promote use and feature data quality metrics
- Work with CD3 stakeholders to promote CD3 use and best practice sharing
- Understand the limits of what CD3 information should and should not be used for
- Gather more information and high-resolution maps about boat launch setup and vegetation in the area

Key Insights Meta Analysis

		1	2	3	4	5	6	7	8	9
		Hour With Most Uses	Day With Most Uses	Day With Second Most Uses	Year With Most Uses	Year With At Least Uses	Yearly Use Trend 21 To 22	Tool With Most Uses	Tool With Least Uses	Significant Outliers Detected
1	Spring Park Mtka Solar	4:00 PM	Saturday	Sunday	2018	2022	DOWN	Grabber	Light	YES
2	Bryant	8:00 PM	Sunday	Monday	2019	2017	DOWN	Grabber	Light	YES
3	Riley	8:00 PM	Sunday	Saturday	2019	2022	DOWN	Grabber	Light	YES
4	North Arm Mtka	8:00 PM	Sunday	Saturday	2018	2020	UP	Grabber	Light	YES
5	Long	3:00 AM	Tuesday	Sunday	2020	2022	DOWN	Air	Brush	YES
6	Bush	3:00 AM	Sunday	Tue / Fri	2019	2022	DOWN	Air	Light	YES
7	Champlin Park	3:00 AM	Sunday	Saturday	2021	2022	DOWN	Air	Light	YES
8	Riverside Mississippi	3:00 AM	Saturday	Sunday	2022	2021	UP	Vacuum	Light	YES
9	Medicine Trailer	3:00 AM	Sunday	Saturday	2021	2020	DOWN	Air	Brush	YES
10	Grays Bay Mtka	8:00 PM	Sunday	Saturday	2022	2022	NA	Air	Light	NO
11	Spring Park Outpost 1	8:00 PM	Sunday	Wednesday	2020	2022	DOWN	Brush	Light	YES
12	Spring Park Outpost 2	4:00 PM	Sunday	Tuesday	2019	2020	DOWN	Brush	Light	YES
13	Fish Lake	3:00 AM	Saturday	Friday	2022	2021	UP	Brush	Light	YES
14	Sarah	11:00 AM	Tuesday	Saturday	2020	2021	FLAT	Grabber	Light	YES
15	Weaver	3:00 AM	Sunday	Saturday	2019	2022	DOWN	Wrench	Light	YES
16	Parkers	3:00 AM	Sunday	Saturday	2019	2022	DOWN	Grabber	Light	YES
17	Twin Lake / Mitchel	3:00 AM	Saturday	Sunday	2021	2022	DOWN	Wrench	Light	YES
18	Twin Lake / Twin Lake	3:00 AM	Saturday	Sunday	2021	2022	DOWN	Wrench	Grabber	YES
19	Carson's Bay	3:00 AM	Thursday	Monday	NA	NA	NA	Grabber	Light	YES
20	Eagle	12:00 AM	Saturday	Sunday	2021	2022	DOWN	Wrench	Light/Brush	YES
21	Little Long Lake	3:00 AM	Tuesday	Saturday	2021	2022	DOWN	Wrench	Light	YES
22	LMCD	8:00 PM	Saturday	Sunday	NA	NA	NA	Grabber	Light	NO

Key Insights Meta Analysis

3AM is Most Used Hour at 55% of Locations

1) Hour with Most Uses		
Count of Location		
11:00 AM	1	5%
12:00 AM	1	5%
3:00 AM	12	55%
4:00 PM	2	9%
8:00 PM	6	27%
Total	22	

2019 & 21 Years with Highest Most Uses

4) Year with Most Uses		
Count of Location		
2018	2	9%
2019	6	27%
2020	3	14%
2021	6	27%
2022	3	14%
NA	2	9%
Total	22	

Grabber Most Uses at 36% of Locations

7) Tool with Most Uses		
Count of Location		
Air	5	23%
Brush	3	14%
Grabber	8	36%
Vacuum	1	5%
Wrench	5	23%
Total	22	

Sunday is Most Used Day at 50% of Locations

2) Day with Most Uses		
Count of Location		
Saturday	7	32%
Sunday	11	50%
Thursday	1	5%
Tuesday	3	14%
Total	22	

2022 was Year of Least Use for 59% of Locations

5) Year with Least Uses		
Count of Location		
2017	1	5%
2020	3	14%
2021	3	14%
2022	13	59%
NA	2	9%
Total	22	

Light is Least Used Tool at 82% of Locations

8) Tool with Least Uses		
Count of Location		
Brush	2	9%
Grabber	1	5%
Light	18	82%
Light/Brush	1	5%
Total	22	

Sat /Sun 2nd Most Used Day at 73% of Locations

3) Day with 2nd Most Uses		
Count of Location		
Friday	1	5%
Monday	2	9%
Saturday	9	41%
Sunday	7	32%
Tue / Fri	1	5%
Tuesday	1	5%
Wednesday	1	5%
Total	22	

68% of Locations had Downward Use Trend 21-22

6) Yearly Use Trend 21-22		
Count of Location		
DOWN	15	68%
FLAT	1	5%
NA	3	14%
UP	3	14%
Total	22	

91% of Locations had Significant Outlier Detected

9) Significant Outliers Detected		
Count of Location		
NO	2	9%
YES	20	91%
Total	22	

Significant Outlier Example – Spring Park Solar

8 - Tool use by month per year (green = high / red = low)

	Mar	Apr	May	Jun	Jul	Aug	Sep	Oct	Nov	Total
2017						167	57	652	23	1417
2018			470	1156	64	831	599	1666		5369
2019		113	692	468	721	1920	90	671		4676
2020				235	1098	530	612	759		3234
2021	152	100	3	832	744	781	882	188		4029
2022		1	276	2011	584	466	602	75		4017
Total	152	214	1790	4702	3795	4695	3360	4011	23	22742

Asset	Sensor	Value	Value Delta	Time Int	CDT Convert
Spring Park Grabber		7626	0	5:00	6/29/2022 20:10
Spring Park Grabber		7694	68	5:00	6/29/2022 21:10
Spring Park Grabber		7797	103	5:00	6/29/2022 22:10
Spring Park Grabber		7839	42	5:00	6/29/2022 23:10
Spring Park Grabber		7990	151	5:00	6/30/2022 0:10
Spring Park Grabber		8047	57	5:00	6/30/2022 1:10
Spring Park Grabber		8287	240	5:00	6/30/2022 2:10
Spring Park Grabber		8539	252	5:00	6/30/2022 3:10
Spring Park Grabber		8799	260	5:00	6/30/2022 4:10
Spring Park Grabber		8799	0	5:00	6/30/2022 5:10

A 1173 Uses in 9 hours

B 1308 Uses in less than 2 days

C 566 Uses in 3 days with Weather History - high wind and precipitation

A Weather History - high wind and 50+ mph wind gusts

B Weather History - high wind and precipitation

Asset	Sensor	Value	Value Delta	Time Int	CDT Convert
Spring Park Grabber		2356	12	5:00	8/23/2019 23:22
Spring Park Grabber		2378	22	5:00	8/24/2019 0:22
Spring Park Grabber		2378	0	5:00	8/24/2019 1:22
Spring Park Grabber		2378	0	5:00	8/24/2019 2:22
Spring Park Grabber		2401	23	5:00	8/24/2019 3:22
Spring Park Grabber		2409	8	5:00	8/24/2019 4:22
Spring Park Grabber		2413	4	5:00	8/24/2019 5:22
Spring Park Grabber		2428	15	5:00	8/24/2019 6:22
Spring Park Grabber		2484	56	5:00	8/24/2019 7:22
Spring Park Grabber		2492	8	5:00	8/24/2019 8:22
Spring Park Grabber		2493	1	5:00	8/24/2019 9:22
Spring Park Grabber		2500	7	5:00	8/24/2019 10:22
Spring Park Grabber		2528	28	5:00	8/24/2019 11:22
Spring Park Grabber		2659	111	5:00	8/24/2019 12:22
Spring Park Grabber		2821	182	5:00	8/24/2019 13:22
Spring Park Grabber		2915	94	5:00	8/24/2019 14:22
Spring Park Grabber		2980	65	5:00	8/24/2019 15:22
Spring Park Grabber		3056	76	5:00	8/24/2019 16:22
Spring Park Grabber		3120	64	5:00	8/24/2019 17:22
Spring Park Grabber		3160	40	5:00	8/24/2019 18:22
Spring Park Grabber		3183	23	5:00	8/24/2019 19:22
Spring Park Grabber		3183	0	5:00	8/24/2019 20:22
Spring Park Grabber		3184	1	5:00	8/24/2019 21:22
Spring Park Grabber		3198	14	5:00	8/24/2019 22:22
Spring Park Grabber		3160	-38	5:00	8/25/2019 0:22
Spring Park Grabber		3363	31	5:00	8/25/2019 3:22
Spring Park Grabber		3387	24	5:00	8/25/2019 4:22
Spring Park Grabber		3431	44	5:00	8/25/2019 5:22
Spring Park Grabber		3469	38	5:00	8/25/2019 6:22
Spring Park Grabber		3490	21	5:00	8/25/2019 7:22
Spring Park Grabber		3499	9	5:00	8/25/2019 8:22
Spring Park Grabber		3510	11	5:00	8/25/2019 9:22
Spring Park Grabber		3516	6	5:00	8/25/2019 10:22
Spring Park Grabber		3535	19	5:00	8/25/2019 11:22
Spring Park Grabber		3552	17	5:00	8/25/2019 12:22
Spring Park Grabber		3617	65	5:00	8/25/2019 13:22
Spring Park Grabber		3645	28	5:00	8/25/2019 14:22

